



Noodoe EV AC19L/AC19L Exceed User Manual



Dust and Water
Protection NEMA 3R



Authorization



Management



Easy
Maintenance



Easy Installation

Distributed by powertechnologysolutions.com

📍 100 Ashley Dr S, Tampa, FL 33402

☎ Phone: (813) 314-7617

✉ E-mail: sales@powertechnologysolutions.net

CONTENTS

Introduction/User Experience /Noodoe EV Operating System (EV OS)/ Autonomous Revenue Generation.....	2
Pricing/User Management/Extensibility	3
1. Important Safety Instructions	4
2. Introduction	7
2.1 Product View.....	7
2.2 Carton Opening Process.....	9
3. Specifications	11
3.1 Product specifications.....	11
4. Installation	13
4.1 Before Installation	13
4.2 Tools & Parts Required for Installation	14
4.3 Charge Point Installation	15
4.4 Input Power Cord Installation	21
4.5 Holster Installation	25
4.6 Gateway Installation	28
4.7 Gateway Installation Scenario.....	29
5. Getting Started	30
5.1 Setting Up the Local Network	30
5.2 Web-page Overview	31
5.3 Configuration	36
5.4 Maintenance	59
5.5 EVSE Status	63
5.6 LLM Status	64
5.7 Security.....	76
6. Activation Instructions	77
6.1 Activation Overview	77
6.2 Prior to Activation	78
6.3 Creating a Site.....	79
6.4 Adding Charging Stations.....	80
6.5 Taking Charging Station Photos.....	80
7. Operations	81
7.1 Charging Status Indicators	81
7.2 Authorization (for AC19L Exceed Only)	82
7.3 Charging an Electric Vehicle (EV)	83
7.4 Stop charging.....	84
7.5 General care	85
7.6 Customer support	85
8. Federal Communication Commission Interference Statement	86
9. Industry Canada Statement	87
10. Maintenance and Repair	89
10.1 Daily Maintenance	89
10.2 Maintenance Supplies	89

Introduction

Noodoe EV AC chargers offer convenience and efficiency to both customers and service providers. These charging stations feature simple installation and management. AC chargers are easy additions to any location and are highly requested by EV-driving customers. They are excellently suited to retail and commercial parking lots, workplaces, restaurants, multi-unit dwellings, and anywhere else looking to provide a smooth, convenient charging experience. Noodoe EV AC chargers are sturdy and can stand up to the elements. They are safety certified, and the design is both waterproof and dustproof. Install them anywhere without environmental concerns.

User Experience

The Noodoe EV charger is easy to engage with and use. It features a simple design to make charging a truly painless experience. Drivers need only scan, plug in, and charge. No annoying memberships or app downloads are necessary. Users can begin charging either through an authorized RFID smart card (perfect for office staff or apartment buildings), the Noodoe mobile app, or our online web portal.

Noodoe EV Operating System (EV OS)

Noodoe EV OS is a cloud-based operating system that unifies the management of all Noodoe EV charging stations. It centralizes charger operation and streamlines the administration of the entire charging network. The EV OS dashboard pulls together information from every connected charger, providing a wealth of information right at your fingertips. Revenue generation becomes practically hands-free as EV OS implements your chosen settings. It even runs charging station diagnostics and self-repair protocols, dramatically reducing the need for expensive maintenance and repairs.

Autonomous Revenue Generation

- Noodoe EV OS supports autonomous revenue generation by streamlining all aspects of EV charger management.
- Service providers have access to up-to-the-minute data on usage, monetization, power status, and more.

- Noodoe EV AC chargers support universal, automatic pay-at-the-pump transactions through Apple Pay, Google Pay, credit cards, or the membership management program in Noodoe EV OS.
- Funds automatically transfer to the management-designated account.

Pricing

- Connect chargers from multiple sites to a shared network in Noodoe EV OS, enabling pricing changes right from the EV OS dashboard.
- Change pricing and availability on the fly or via pre-set, automated schedules with the click of a button.
- Set pricing based on either time taken (price per minute) or energy usage (price per kW).
- Enjoy set-it-and-forget-it automatic peak hour price changes.

User Management

- Chargers can offer multiple pricing tiers through EV OS's integrated user management system.
- Users can make payments through at-the-pump mobile transactions or targeted membership plans for VIPs, special guests, residents, or staff.
- Membership management allows for charging to be available to a select few as a free amenity while still requiring payment by the wider public.
- Integrated user management is ideal for staff and fleet charging, leaving unused chargers available for public use.

Extensibility

- Noodoe EV offers additional software services specially developed for a wide range of charging environments, including those for fleets, workplaces, residences, shopping centers, dealerships, gas stations, smart cities, and more.
- To support the different needs of our customers, Noodoe EV AC chargers support intelligent load balancing, distributing power across multiple chargers on the same network.
- Noodoe EV load balancing means more chargers can be installed on the same site without costly site upgrades.

1. IMPORTANT SAFETY INSTRUCTIONS

This document contains instructions and warnings that must be followed when installing and using the Electric Vehicle Supply Equipment (EVSE). Before installing or using the EVSE, read this entire document as well as WARNING and CAUTION markings in this document.

Safety Instructions

The symbols used have the following meaning:



WARNING: RISK OF PERSONAL INJURY



WARNING: RISK OF ELECTRIC SHOCK



WARNING: RISK OF FIRE



CAUTION: RISK OF DAMAGE TO THE EQUIPMENT

- The information provided in this manual in no way exempts the user of responsibility to follow all applicable codes or safety standards.
- This document provides instructions for the Electric Vehicle Supply Equipment (EVSE) and should not be used for any other product.

Repair and Maintenance Clause

- Only licensed electricians can repair or maintain this equipment. It is forbidden for general users to repair or maintain it.
- Turn off input power before repair or maintenance of the charge point.



WARNING: RISK OF ELECTRIC SHOCK

When using electric products, basic precautions should always be taken. This manual contains important instructions that shall be followed during installation, operation and maintenance of the unit.

- Read all instructions before using this product.
- Children should not use the device without adult supervision.
- Do not insert fingers into the EV connector.
- Do not use this product if the flexible power cord or EV cable is frayed, has broken insulation, or displays any other signs of damage.
- Do not use this product if the enclosure or the EV connector is broken, cracked, open, or shows any other indication of damage.
- To avoid the risk of fire or electric shock, do not use this unit with an extension cord.



WARNING: RISK OF ELECTRIC SHOCK

Improper connection of the equipment grounding conductor can result in a risk of electric shock. Check with a qualified electrician or serviceman if you are in doubt as to whether the product is properly grounded.

Do not modify the plug provided with the product. If it will not fit the outlet, have a proper outlet installed by a qualified electrician.



WARNING: RISK OF ELECTRIC SHOCK

Do not remove the cover or attempt to open the enclosure. There are no user serviceable parts inside. Refer servicing to qualified service personnel.



WARNING: RISK OF ELECTRIC SHOCK

- Do not touch live electrical parts.
- Incorrect connections may cause electric shock.
- Do not disconnect under load.



WARNING: This equipment is intended only for charging vehicles that do not require ventilation during charging. Please refer to your vehicle's owner's manual to determine ventilation requirements.



WARNING: Do not use extender cables to increase the length of the charging cable. Maximum length is limited to 25 feet by the National Fire Protection Agency.



WARNING: Do not drag the charge point by its input power cord.



CAUTION: Do not expose to liquid, vapor, or rain.



CAUTION: If this unit is installed outdoors, the outlet must be rated for outdoor installation. The outlet must be installed properly to maintain the proper NEMA rating of the enclosure.

- Installation work and electrical wiring must be done by qualified person(s) in accordance with all applicable codes and standards, including fire-rated construction.
- Do not touch the terminals or other current-carrying parts.
- Take care not to drill into any pipes or power lines beneath the surface when preparing the mounting holes. Use a power line / metal detector.
- Do not trample or drive over the product's cables.
- Do not put any foreign objects into the enclosure.
- Do not start the vehicle's engine when the charging connector is still connected.



CAUTION: Do not use this product if there is any damage to the unit. In the event that the unit is not operational, send it back to the manufacturer.

SAVE THESE INSTRUCTIONS

2. Introduction

This user manual applies to “80 A Level 2 AC Charger for Plug-in Electric Vehicles (PEVs) and Battery Electric Vehicles (BEVs)”.

This Level 2 Electric Vehicle Supply Equipment (EVSE) with 80 A capabilities is for use in North America. It can provide a shorter charging time than the 16 A and 32 A EVSE.

Any unauthorized modifications will void the manufacturer’s warranty.

2.1 Product View



Front view

2.1.1 Box Contents

Inside the box, you will find the following accessories.

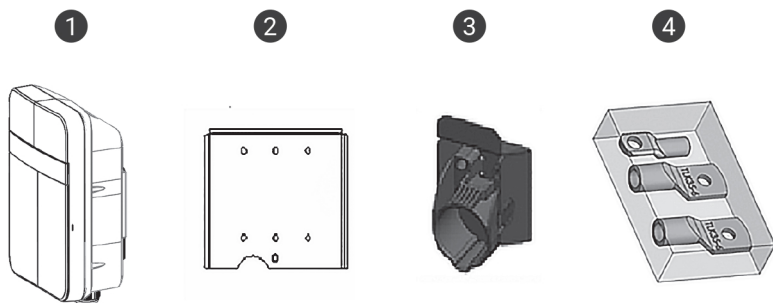

Box contents

2.1.2 Accessories in the Box

	Description	QTY	Remark
1	AC19L	1	
	AC19L Exceed		
2	Mounting Bracket	1	Attached to the back of the charge point
3	Holster ASSY	1	Hook x1, Holster x1 & M4xL15 tapping screw x2
4	Accessories Bag	1	#2 AWG Ring terminal lug x 2, #8 AWG Ring terminal lug and M6 machine screw x1

2.2 Carton Opening Process

Step 1.

Open the carton and remove the EPE Foam.

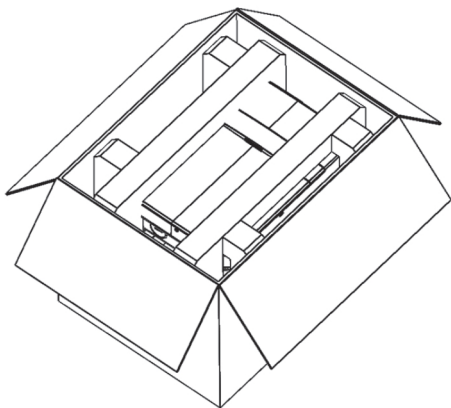

Opening the carton

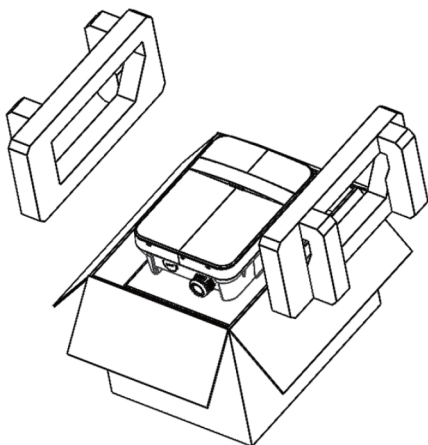

Charge point device

Step 2.

Take out the charge point and then remove the mounting bracket before installing it.

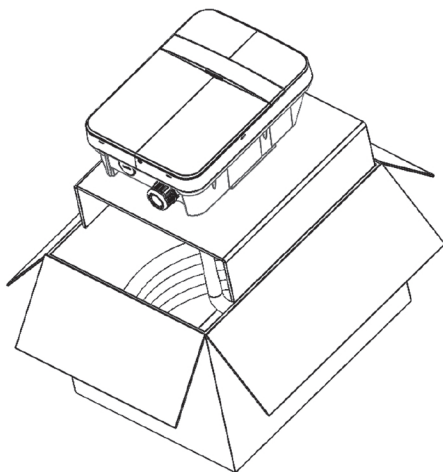

Take out the charge point

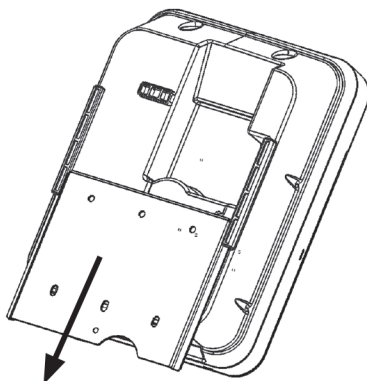

Remove the mounting bracket

3. Specifications

3.1 Product specifications

Model Name	AC19L	AC19L Exceed
Application	Commercial	
Voltage (Vac)	200~240 Vac, 1-phase	
Frequency (Hz)	60 Hz	
Current (Rms)	80 A maximum	
Charging Connector	SAE J1772	
Charging Cable Length	25 feet / 7.6 m	
Metering Accuracy	Embedded +/- 1%	
Electrical Protection	Over voltage protection, under voltage protection, surge protection, ground fault protection, residual current device, short circuit protection, over current protection, over temperature protection	
Indication	<ul style="list-style-type: none"> • Green Steady: Ready • Green Flashing (Fast): Authorized, waiting for EV to connect • Green Flashing (Slow): Suspended (Occupying) • Blue Flashing (Slow): Charging • Red Steady: Unrecoverable Fault • Red Flashing (Slow): Recoverable Fault • Yellow Flashing (Slow): Booting / Firmware Upgrading / Out of Service <p>Remark:</p> <ul style="list-style-type: none"> • Fast Flash: On Time 300 ms, Off Time 200 ms, 2 Hz • Slow Flash: On Time 1200 ms, Off Time 800 ms, 0.5 Hz 	
Wi-Fi	802.11 b/g/n	
Ethernet	YES	
Cellular	N/A	LTE Cat. M1 (AT&T)
RFID	N/A	ISO 14443 A/B, ISO 15693, NFC, NEMA interoperability protocol

Model Name	AC19L	AC19L Exceed
Display	OLED, 20 characters, 2 lines	
Communication Protocol	OCPP 1.6 JSON	
Operation Temperature	-35~55 °C / -31~131 °F	
Storage Temperature	-40~80 °C / -40~176 °F	
Mounting Type	Wall mount / Pole mount (optional)	
Wiring Type	Hard-wired	
NEMA Enclosures (NEMA)	NEMA 3R	
Impact Protection	IK10	
Dimensions	10.6 (W) x 14.1(H) x 5.5 (D) in 270 (W) x 360 (H) x 140 (D) mm	
Web Portal Management	Yes	
Console Management	Yes	
Certification	UL 1998/2231/2594 FCC Part 15B	
	FCC Part 15.225 (RFID 13.56 MHz) FCC Part 15.247 (WLAN 2.4 GHz) Energy Star	
	N/A	FCC Part 22/24/27

4. Installation

4.1 Before Installation

4.1.1 Safety check

- Check for damages incurred during transportation.
- Before connecting the product to the power supply, check that the power supply voltage and current ratings correspond with the power supply details shown on the product rating label.



CAUTION: Disconnect the power supply before installing or repairing the charge point. Failure to do so may result in physical injury or damage to the power supply system and the charge point.



CAUTION: Avoid touching or pressing the OLED screen at all times, as this may result in damage to the OLED screen.



DANGER: RISK OF SUFFOCATION

Keep any packing materials away from children. These materials are a potential source of danger, e.g. suffocation.



CAUTION: Cord extension sets are not allowed to be used.

The charge point must be installed only by a licensed electrician in accordance with the provisions of the local electrical industry construction and should comply with national electrical codes and standards.

Before installing the charge point, make sure you have read all instructions in this manual and fully understand its contents.

Appropriate protection is required when connecting to a main switchboard. The tools and parts to be used are outlined in the section “Tools & parts required for installation”.

4.1.2 Grounding Instructions

The charge point must be grounded through a permanent wiring system or an equipment grounding conductor. Use a wire that has a dedicated grounding wire and a ring terminal that connects to the equipment ground terminal block for grounding.

4.2 Tools & Parts Required for Installation

Tool	QTY	Model	Size	Supplier	Remark
Mounting Bracket	1	All	222x173x9 mm	All Product Model	Fasten charge point to the wall
Holster ASSY	1	All	58x58x70 mm	Model Accessories	Hold EV charging plug
Screw	4	All	Tapping: #12	Commercially Available	Fasten mounting bracket & hook
			Mechanical: M6		
	1	All	Mechanical: M6	Model Accessories	Fasten charge point & mount bracket
Wire, Copper	3	All	2 AWG	Commercially Available	
Heat Shrink Tube	3	All	For 2 AWG wire Color: Red, Black, Green.	Model Accessories	Protect wires & terminals
Terminal	3	All	For 2 AWG wire	Model Accessories	Connect input wires to the terminal block
Conduit	1	All	1 inch	Commercially Available	Protect power cable
Torx Screwdriver	1	All	T20	Commercially Available	
Philips Screwdriver	1	All	PH3	Commercially Available	
Hexagon Socket	1	All	5/16	Commercially Available	Tighten #12 Tapping screws
Torque Wrench	1	All	40 kgf-cm min	Commercially Available	

4.3 Charge Point Installation

4.3.1 Disassemble the Top Cover.

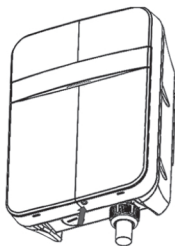

Step 1

Loosen 1 pc M4 screw.

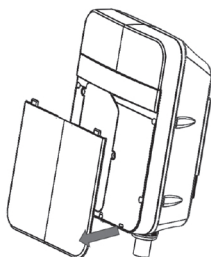

Step 2

Use a flat-tip screwdriver to push snap then open the front cover.

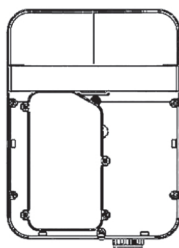

Step 3

Loosen 5 pcs M4 screw then open install cover.

4.3.2 Find SIM card socket. (Only for AC19L Exceed)

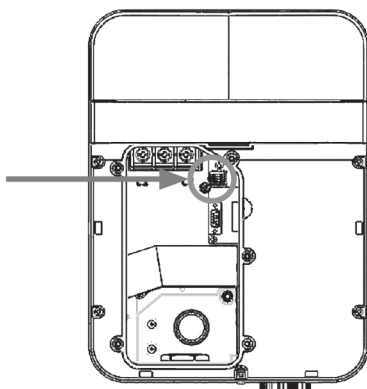

Position of SIM card socket

4.3.3 Insert SIM card.

Step 1

Unlock the SIM Card socket.

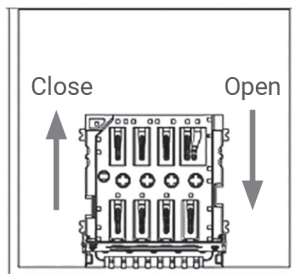

SIM card socket and cover
Open/Close direction

Step 2

Open the socket then install the SIM card.

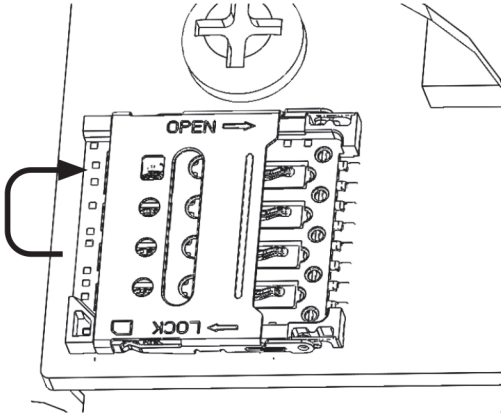

open the socket cover

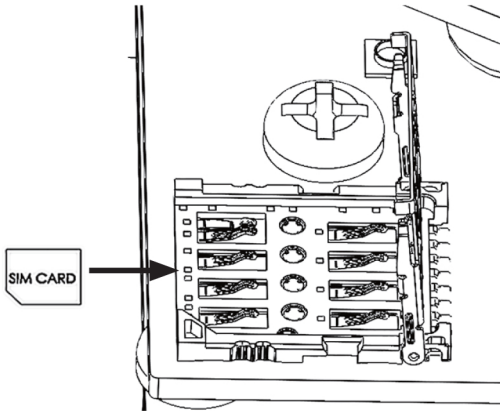

Input the SIM Card

4.3.4 Secure the main body mounting bracket to the wall with the appropriate screw.

Follow applicable accessibility requirements for the mounting position. The unit shall be stored or located at an appropriate height. For indoor use: The unit shall be mounted between 18 inches (450 mm) and 4 feet (1.2 m) from the floor. For outdoor use: The unit shall be mounted between 24 inches (600 mm) and 4 feet (1.2 m) from the floor. Refer to Article 625, NEC.

The mounting bracket has ten screw holes. If only two screws are used to fasten the mounting bracket, those screws should pass through the middle two screw holes of the mounting bracket. The other screw holes are reserved for the user.

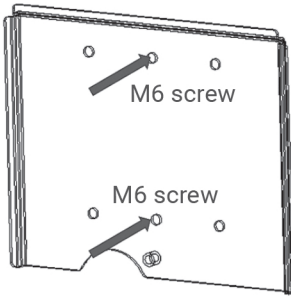

Fasten mounting bracket

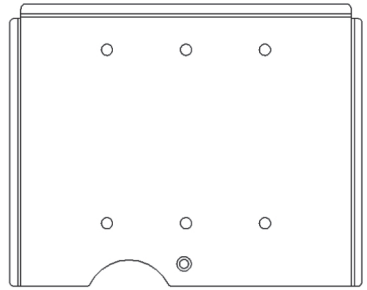

Screw holes of mounting bracket

Screw suggestion:

1. For masonry walls, use M6 mechanical screws. (Commercially Available)
2. For finished walls supported by wood studs, use #12 tapping screws. (Model Accessories)
3. Please refer to the following torque. The actual torque is according to the wall material.

Screw	Torque	
M6	25 kgf.cm min	21.7 lb-in min
#12	25 kgf.cm min	21.7 lb-in min

4.3.5 Fasten charge point onto mounting bracket.

1. Put the charge point on the mounting bracket.
2. Fasten the charge point on the mounting bracket by tightening the M6 screw.
3. Please refer to the following torque.

Screw	Torque	
M6	30 kgf.cm	26.9 lb-in

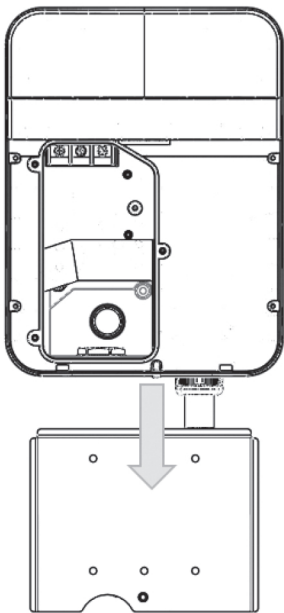

Charge point and mounting bracket

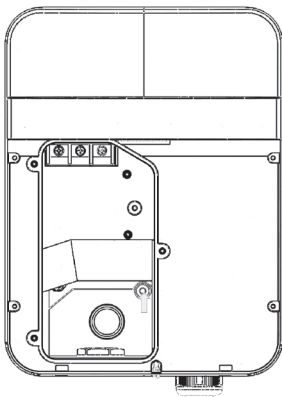

Tighten M6 screw

4.4 Input Power Cord Installation

4.4.1 Choose the appropriate conduit in accordance with all applicable state, local, and national electrical codes and standards.

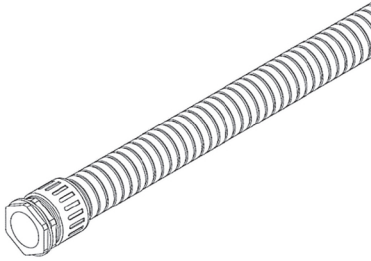

Conduit

4.4.2 Clamp copper terminal to connect the copper wire. The clamping point is covered by heat shrink tubing for protection.

Refer to the following wire specification. Use a conductor type other than RHH, and RHW-2 with outer covering.

Model	Terminal	Conductor	Rating
	L1, L2	2 AWG	90C copper wire
	G	8 AWG	

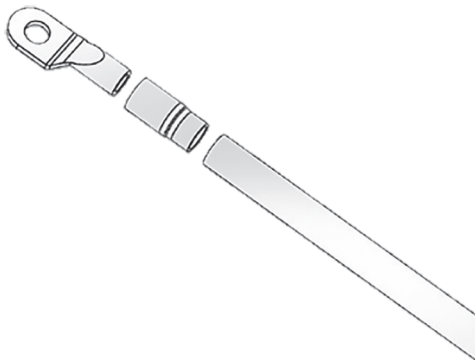

Copper terminal, heat shrink tube and copper wire

4.4.3 Electrical wiring to the charge point.

1. Fold the wire end to pass through the conduit and insert them into the input hole (choose input direction 1 or 2 and open cap).

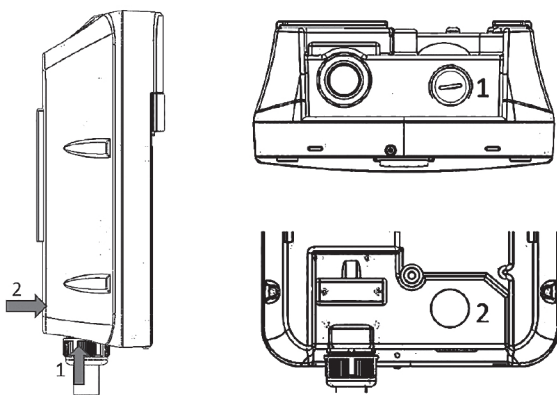

Cable input position

2. Fasten the copper wire on the corresponding terminal block. The wiring instruction is printed in front of the terminal block (L1/L2/G).

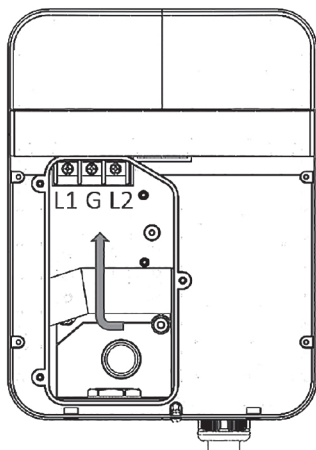

Input wiring position

3. Use the following torque to connect the wire terminal to the terminal block.

Screw	Torque	
M6	30 kgf.cm	26.9 lb-in



CAUTION: To reduce the risk of fire, connect only to a circuit provided with 100 amperes maximum branch circuit overcurrent protection in accordance with the National Electrical Code, ANSI/NFPA 70, and the Canadian Electrical Code, Part I, C22.1.



CAUTION: If this unit is installed outdoors, the outlet must be rated for outdoor installation. The outlet must be installed properly to maintain the proper NEMA rating of the enclosure.

4. Lock the conduit on the enclosure. Please refer to the following torque.

Conduit	Torque	
1 "	35 kgf.cm	30.36 lb-in

5. Reassemble install cover and front cover then fasten M4 screw.

Screw	Torque	
M4	15 kgf.cm	12 lb-in



Please visit the official website for more information and video walkthroughs for installing your AC19L/AC19L Exceed.

4.5 Holster Installation

4.5.1 Separate the holster from the hook.

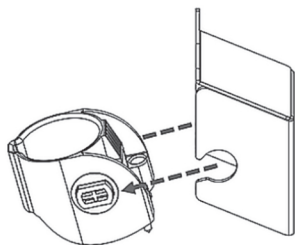

Separate the holster

4.5.2 Fasten the hook to the wall with appropriate screws.

1. For finished walls supported by wood studs, use #12 tapping screws (x2).
2. The recommend torque is 25 kgf.cm (21.7 lb-in).

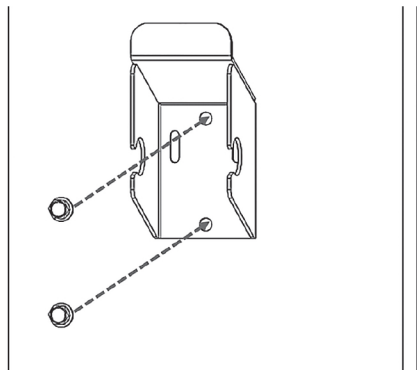

Secure the hook

4.5.3 Make the holster face up and combine it with the hook.

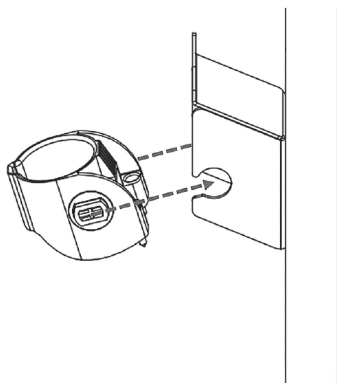

Secure the holster

4.5.4 Rotate the holster down totally.

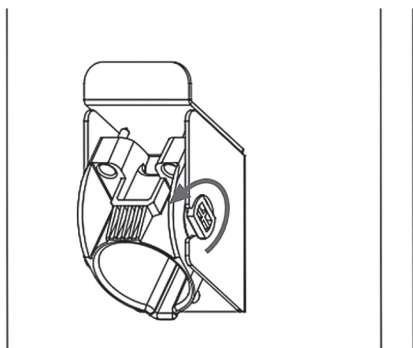

Rotate the holster

4.5.5 Keep the holster in this state and tighten the screws completely.

1. The recommend torque is 6 kgf.cm (5.2 lb-in). The screws make the combination firm.

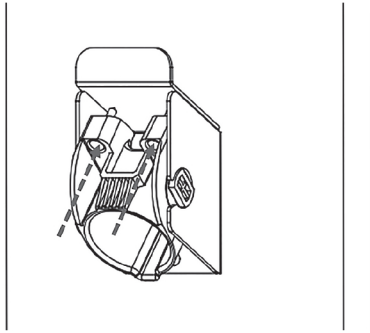

Tighten screws

4.5.6 Place the EV charging plug in the holster.

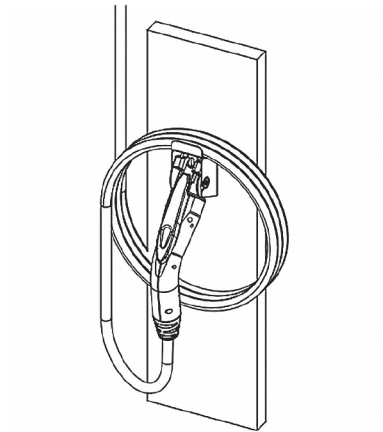





Place EV charging plug

4.6 Gateway Installation

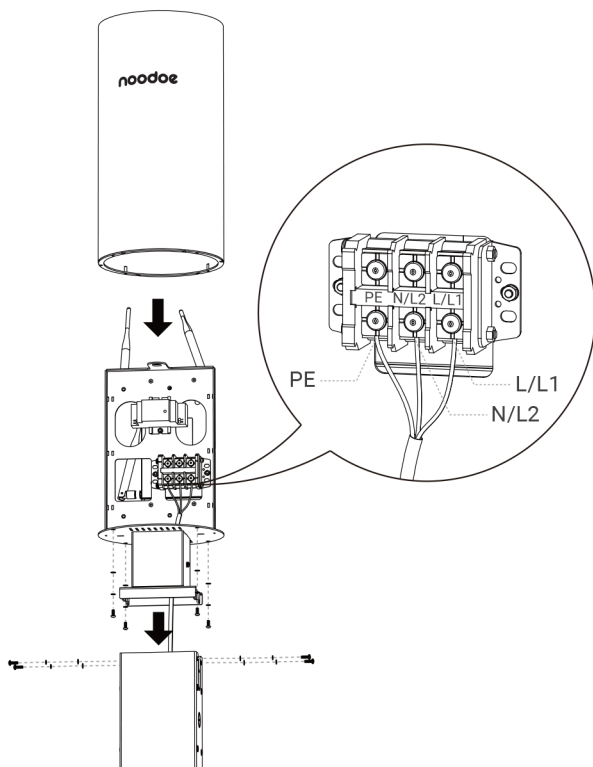
For consistent internet access, we recommended using the Noodoe EV Gateway G120 (please contact Noodoe to purchase).

4.6.1 Mounting on the pedestal



No.	Part	Name of Part	Unit
1		M4*12 Phillips Pan Head screws	4
2		M4 Plain washers	8
3		M4 Spring washers	8
4		M4x10 Hex Drive Screws	4

4.7 Gateway Installation Scenario

As different installation environments may affect connection quality, we highly recommend thorough consideration of the installation site layout prior to installation. The proper layout will help prevent suboptimal connection quality or disconnection issues.

Best receiving range: radius 18 m (60 feet).

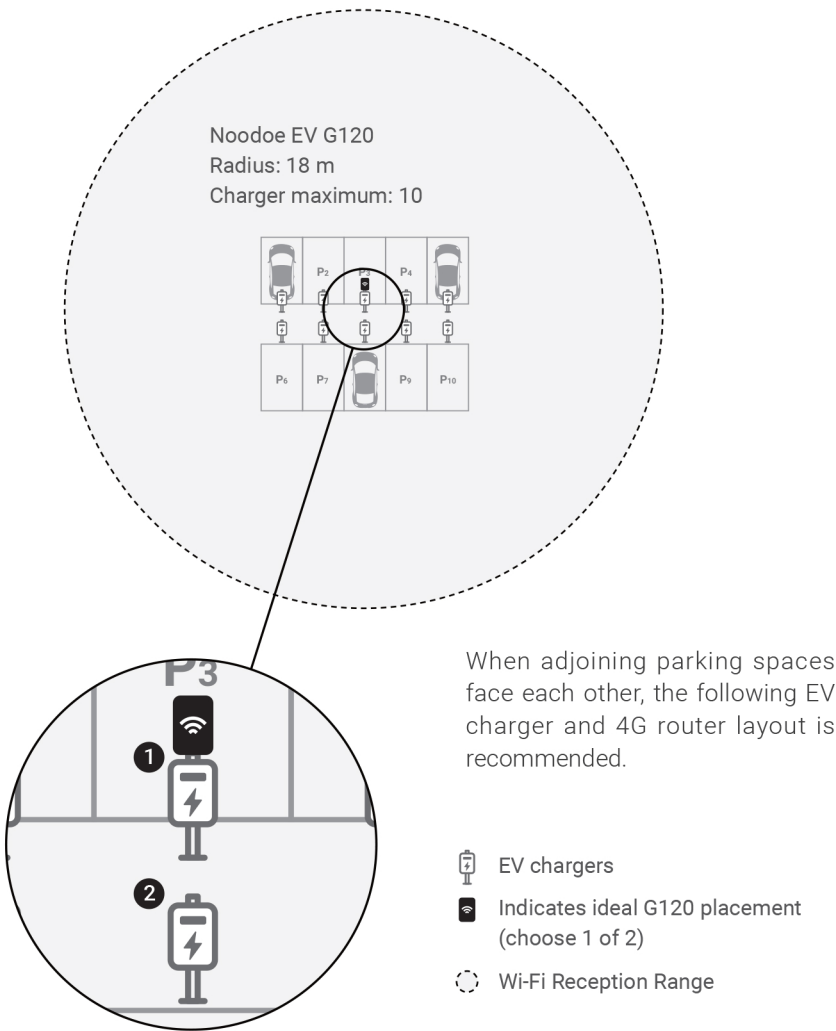

5. Getting Started

5.1 Access charger via browser

5.1.1 Setting up the local network

The default factory setting of networks is Wi-Fi AP mode. You can get the SSID number from the label on the side of the charge point. Please refer to the below figure. The SSID name is IC80A+SN. Then you can connect a computer/smartphone/iPad to the charge point using Wi-Fi. The default password is "SN+@IC80A"

Ex. SN : EX-1193-1A13-1-1234-2444,

The SSID name is IC80AEX-1193-1A13-1-1234-2444.

The password is EX-1193-1A13-1-1234-2444@IC80A.

Step 1.

Connect a computer to the charge point using Wi-Fi.

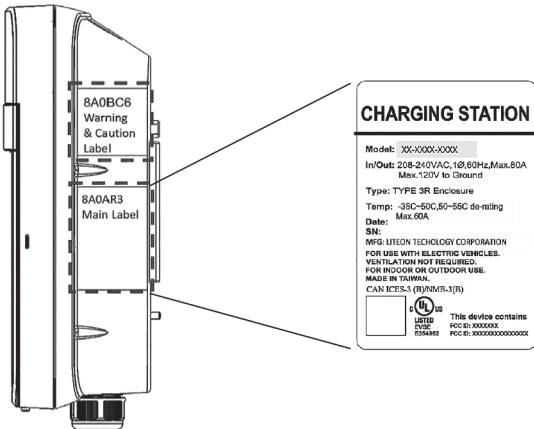

SN on the main label

5.1.2 Log In

Open a web browser (such as Internet Explorer) and enter the IP address (10.10.0.1) in the address field of the browser and press enter.

Now you should see the login screen:

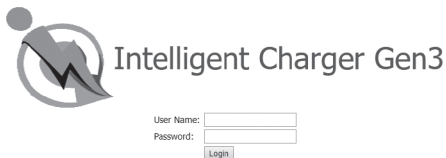

To be able to configure the charge point you should enter "**admin**" in the user name box. The default password is "**howru2RU2IC3**".

5.2 Web-page Overview

5.2.1 Menu Overview

To navigate via the web browser, use the menu items available: Configuration, Maintenance, EVSE Status, LLM Status, and Security.

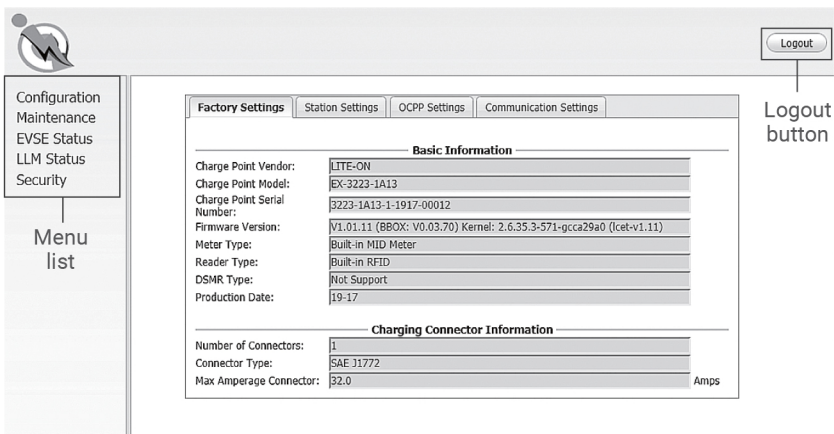

The screenshot displays the web interface of the Intelligent Charger Gen3. On the left side, there is a "Menu list" with the following items: Configuration, Maintenance, EVSE Status, LLM Status, and Security. The main content area is titled "Factory Settings" and includes sub-tabs for "Station Settings", "OCPP Settings", and "Communication Settings". The "Basic Information" section contains the following data:

Charge Point Vendor:	LLTE-ON
Charge Point Model:	EX-3223-1A13
Charge Point Serial Number:	3223-1A13-1-1917-00012
Firmware Version:	V1.01.11 (BBOX: V0.03.70) Kernel: 2.6.35.3-571-gcca29a0 (lctet-v1.11)
Meter Type:	Built-in MID Meter
Reader Type:	Built-in RFID
DSMR Type:	Not Support
Production Date:	19-17

The "Charging Connector Information" section contains the following data:

Number of Connectors:	1
Connector Type:	SAE J1772
Max Amperage Connector:	32.0 Amps

On the right side of the interface, there is a "Logout button".

5.2.2 Configuration Menu

When you choose the **Configuration** menu, a sub-menu will appear:

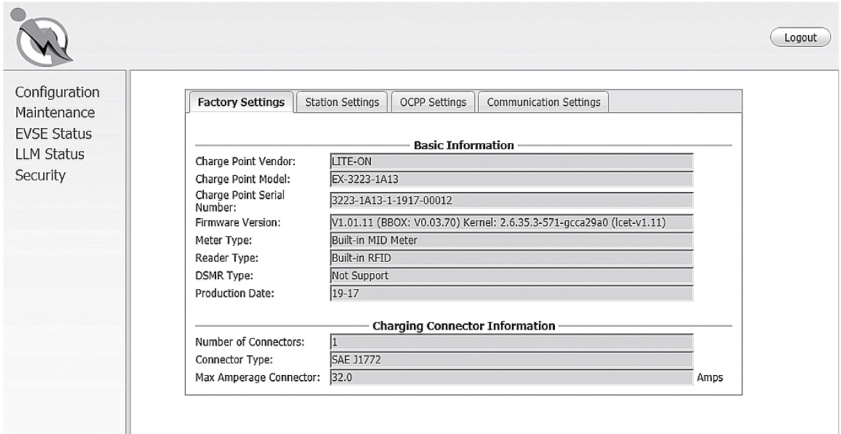

The screenshot shows a web interface with a top navigation bar containing a logo on the left and a "Logout" button on the right. Below the navigation bar is a sidebar menu with the following items: Configuration, Maintenance, EVSE Status, LLM Status, and Security. The main content area displays the "Factory Settings" tab, which is active. This tab contains two sections: "Basic Information" and "Charging Connector Information".

Basic Information	
Charge Point Vendor:	LITE-ON
Charge Point Model:	EX-3223-1A13
Charge Point Serial Number:	3223-1A13-1-1917-00012
Firmware Version:	V1.01.11 (BBOX: V0.03.70) Kernel: 2.6.35.3-571-gcca29a0 (lctet-v1.11)
Meter Type:	Built-in MID Meter
Reader Type:	Built-in RFID
DSMR Type:	Not Support
Production Date:	19-17

Charging Connector Information	
Number of Connectors:	1
Connector Type:	SAE J1772
Max Amperage Connector:	32.0 Amps

- The **"Factory Settings"** tab is used to display the information of the charge point.
- The **"Station Settings"** tab is used to set up the configuration of the charge point itself.
- The **"OCPP Settings"** tab is used to set up the custom properties for use in OCPP 1.6 services.
- The **"Communication Settings"** tab is used to set up the network connection and load management.

5.2.3 Maintenance Menu

When you choose the **Maintenance** menu, a sub-menu will appear:

Configuration
Maintenance
EVSE Status
LLM Status
Security

Command

Reboot

Reset to MFG default

Charging Profile Data

Show All Charging Profile Data Clear All Charging Profile Data

Local Authorization

Show Local Authorization List Clear Local Authorization List

Choose File: Choose File No file chosen Upload List

Show Authorization Cache List Clear Authorization Cache List

Choose File: Choose File No file chosen Upload Cache

Firmware Upgrade

Choose File: Choose File No file chosen Upload

- The **“Command”** screen can be used to restart the charge point and reset settings to their Manufacturing default.
- The **“Charging Profile Data”** screen can be used to show and clear charging profiles including “Charge Point Max Profile”, “Tx Default Profile” and “Tx Profile”. The charging Profile is defined in OCPP 1.6 specification.
- The **“Local Authorization”** screen can be used to display and clear the Local Authorization List and Authorization Cache List. Both lists are defined in OCPP 1.6 specification.
- The **“Firmware Upgrade”** screen can be used to upgrade the charge point's firmware.

5.2.4 EVSE Status

When you choose the **EVSE Status** menu, a sub-menu will appear:

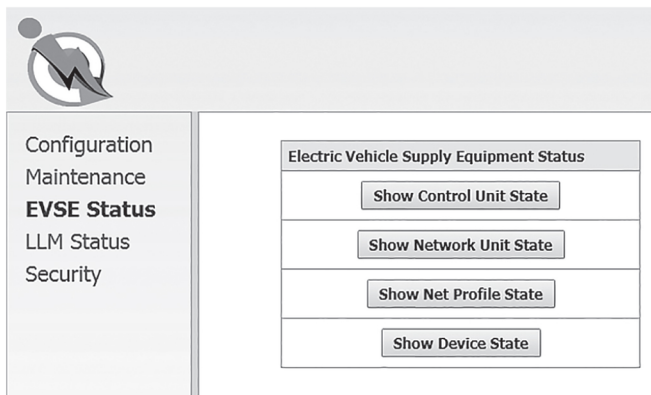

- The **"Electric Vehicle Supply Equipment Status"** can be used to show the EVSE information. Usually, the information is typically only for diagnostic use.

5.2.5 LLM Status Menu (For AC19L Exceed only)

When you choose the **LLM Status** menu, a sub-menu will appear:

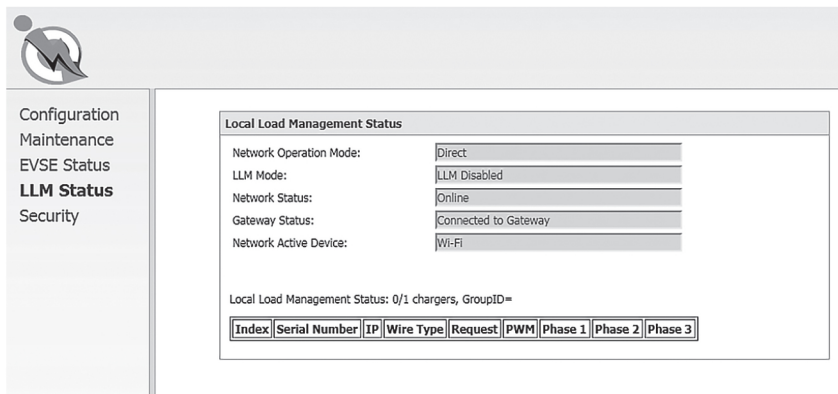

- The **"Local Load Management Status"** screen shows the Local Load Management (LLM) settings and the current Master/Slave group member list.

5.2.6 Security Menu

When you choose the **Security** menu, a sub-menu will appear:

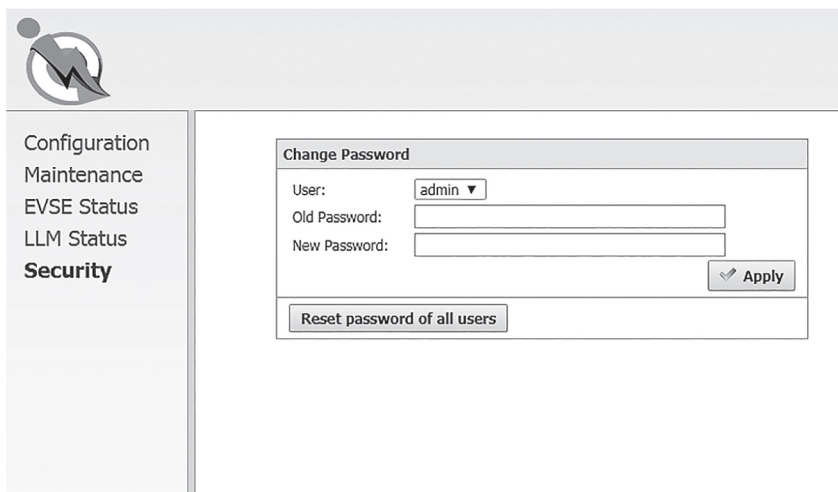

The screenshot shows a web interface with a sidebar on the left and a main content area on the right. The sidebar contains a navigation menu with the following items: Configuration, Maintenance, EVSE Status, LLM Status, and Security (which is highlighted in bold). The main content area displays a 'Change Password' form. The form has a title bar 'Change Password' and contains the following elements: a 'User:' label with a dropdown menu showing 'admin', an 'Old Password:' label with an input field, a 'New Password:' label with an input field, and an 'Apply' button with a checkmark icon. Below the form is a button labeled 'Reset password of all users'.

- The **“Change Password”** screen can be used to change the passwords for users of this web portal.

5.3 Configuration

5.3.1 Factory settings

Clicking on the “**Configuration**” and then “**Factory Settings**” link will bring up the following screen:

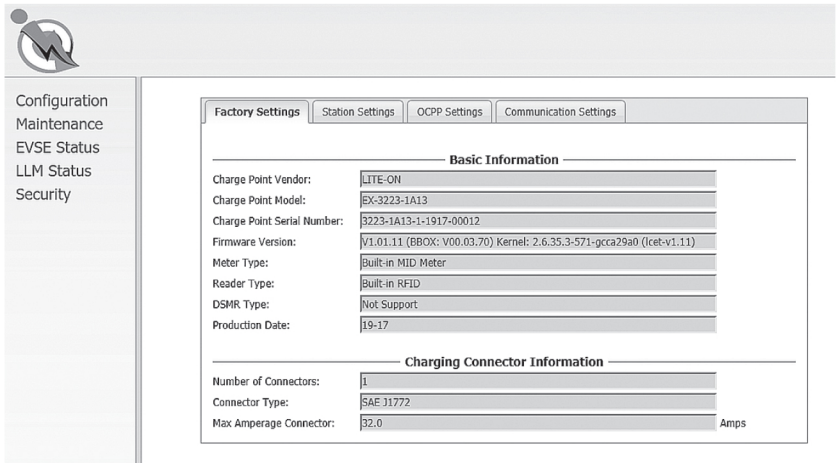

Basic Information	
Charge Point Vendor:	LITE-ON
Charge Point Model:	EX-3223-1A13
Charge Point Serial Number:	3223-1A13-1-1917-00012
Firmware Version:	v1.01.11 (BBOX: V00.03.70) Kernel: 2.6.35.3-571-gcca29a0 (lct-v1.11)
Meter Type:	Built-in MID Meter
Reader Type:	Built-in RFID
DSMR Type:	Not Support
Production Date:	19-17

Charging Connector Information	
Number of Connectors:	1
Connector Type:	SAE J1772
Max Amperage Connector:	32.0 Amps

Basic Information

- **Charge Point Vendor** – The name of the charge point vendor.
- **Charge Point Model** – The charge point model name.
- **Charge Point Serial Number** – The unique serial number of the charge point.
- **Firmware Version** – The software version of the charge point.
- **Meter Type** – The meter type of the charge point.
- **Reader Type** – The reader type of the charge point. (AC19L Exceed only)
- **DSMR Type** – The DSMR type of the charge point.
- **Production Date** – The unit's production date.

Charging Connector Information

- **Number of Connectors** – Number of connectors of the charge point.
- **Connector Type*** – Indicates type 1 or type 2 cable installed on the charge point.
- **Max Amperage Connector** – The maximum charging current of the connector capability.

* A charge point may have multiple connectors installed. For AC19L/AC19L Exceed series, there is only one connector on them.

5.3.2 Station Settings

Clicking on the **“Configuration”** and then **“Station Settings”** link will bring up the following screen. Since the page is too long to display, it is shown here as 2 screens.

On this page, you can change the properties of the charge point. Click the **“Apply”** button to the right side of the property when the value has been changed.

Configuration
Maintenance
EVSE Status
LLM Status

Factory Settings **Station Settings** OCPP Settings Communication Settings

General Settings

Output Power Type: AC

Power Phase Connected: 1

Max Amperage HW Setting: 80.0 Amps

Max Amperage FW Setting: 80.0 Amps

PWM Amperage: 0.00 Amps

Real Amperage: 0.00 Amps

Cold Load Pickup Max Delay: 720 Seconds

Plug and Charge ID:

Reservation Supported: Yes

Resume Charge After Reboot: Off

RFID Reader: On

Ventilation Required: Yes

Skip HeartBeat Message: Yes

LED Brightness: 50 %

Apply

Other Information

Last Boot Time: 2021-04-27 01:57:34 UTC

General Settings

- **Output Power Type** – AC or DC output power. For AC19L/AC19L Exceed series, this value is always “AC”.
- **Power Phase Connected** – Input power phase connected to the charge point to indicate single phase or three phases. For AC19L/AC19L Exceed series, this value is always “1”.
- **Max Amperage HW Setting** – The DIP switches (Hardware) settings to indicate the maximum charging current.
- **Max Amperage FW Setting** – The software settings to indicate the maximum charging current.
- **PWM Amperage** – The PWM setting for charging current when the charge point is online. This signal is used to tell an EV how much current it is allowed to use.
- **Real Amperage** – The real-time charging current detected by the charge point.
- **Cold Load Pickup Max Delay** – Default cold load pickup delay is 120s ~ 720s. The max value could be changed here.
- **Plug and Charge ID** – If the value is present, the charge point needs to support a plug and charge scenario by using the specific identifier. If absent, authorization for each session is required. This ID must be 8 or more characters.
- **Reservation Supported** – If true, the charge point will support reservation related messages from the Central System.
- **Resume Charge After Reboot** – Indicates whether the charge point resumes charging after power recycle. If true, the charge point will resume charging according to UL regulations. If false, the charge point will not resume charging.
- **RFID Reader** – Indicated whether an RFID reader is available. (AC19L Exceed only)

- **Ventilation Required** – Indicates whether ventilation equipment is required. If this option is set to yes, a ventilation fault will occur when the EV report for need ventilation equipment. Recommended setup values are shown below according to the place and ventilation equipment available.

Place	Ventilation Equipment Available	Ventilation Equipment Not Available
Indoor	No	Yes
Outdoor	No	No

- **Skip HeartBeat Message** – When set to true, the Charge Point should skip sending a Heartbeat.req PDU when another PDU has been sent to the Central System within the configured heartbeat interval. The default value is Yes.
- **LED brightness** – The user can modify the LED brightness according to the user's environment and preferences. The default setting is 50% brightness.

Other Information

Last Boot Time: 2018-05-05 14:08:45 UTC

Other Information

- **Last Boot Time** – Shows the last boot time.

5.3.3 OCPP Settings

Clicking on the **“Configuration”** and then **“OCPP Settings”** link will bring up the following screen. As the page is too long to display, please use the scrollbar to check the remaining pages.

Configuration
Maintenance
EVSE Status
LLM Status
Security

Factory Settings | Station Settings | **OCPP Settings** | Communication Settings

Remote Control Settings

Remote Control Type*:

Service Settings

Charge Point ID*:

Protocol Name:

Central System URL*:

Basic Auth ID*:

Basic Auth Password*:

FTP Server Username:

FTP Server Password:

Message Transport Layer:

Boot Notification Interval: Seconds

Boot Notification Retries:

PDU Timeout: Seconds

Download Firmware Interval: Seconds

Download Firmware Retries:

Upload Diagnostic Interval: Seconds

Upload Diagnostic Retries:

On this page, you can change the properties just for the charge point. Click the **“Apply”** button at the right side of the property when the value has been changed.

Remote Control Settings

- **Remote Control Type:** The remote control mode options are
 1. APP: Can be remotely controlled by mobile APP.
 2. OCPP: Can be remotely controlled by OCPP 1.6 protocol.

Service Settings

- **Charge Point ID** – The identity of the charge point as known in the OCPP Central System.

- **Protocol Name** – The name and version of OCPP running on the charge point.
- **Central System URL** – The URL of the OCPP v1.6 Central System service.
- **Basic Auth ID** – The ID for BASIC authentication in HTTPS (SSL/TLS) connections.
- **Basic Auth Password** – The password for BASIC authentication in HTTPS (SSL/TLS) connections.
- **FTP Server Username** – The username of the FTP Server for OCPP to download firmware files and upload diagnostic files.
- **FTP Server Password** – The password of the FTP Server for OCPP to download firmware files and upload diagnostic files.
- **Message Transport Layer** – Select the transport layer of the OCPP service that will be used. The available options are **WS** and **WSS**.
 1. WS: Connection from charge point to OCPP Server uses WebSocket protocol.
 2. WSS: Connection from charge point to OCPP Server uses Secure WebSocket protocol.
- **Boot Notification Interval** – Interval of re-sending BootNotification.req if not accepted by Central System.
- **Boot Notification Retries** – Number of times to retry sending BootNotification.req.
 1. “-1” means unlimited
 2. “0” means don’t retry.
- **PDU Timeout** – Interval until the charge point stops waiting for a PDU response.
- **Download Firmware Interval** – Interval for downloading firmware from Central System.
- **Download Firmware Retries** – Number of times to retry downloading firmware.
- **Upload Diagnostics Interval** – Interval for uploading the diagnostic file to Central System.
- **Upload Diagnostics Retries** – Number of times to retry uploading diagnostic files.



Configuration

Maintenance
EVSE Status
LLM Status
Security

OCPP1.6 Settings

AllowOfflineTxForUnknownId:	Yes ▾	
AuthorizationCacheEnabled:	Yes ▾	
AuthorizeRemoteTxRequests:	No ▾	
BlinkRepeat:	30	Times
ClockAlignedDataInterval:	0	Seconds
ConnectionTimeOut:	120	Seconds
GetConfigurationMaxKeys:	128	
HeartBeatInterval:	43200	Seconds
LightIntensity:	100	%
LocalAuthorizeOffline:	Yes ▾	
LocalPreAuthorize:	Yes ▾	
MaxEnergyOnInvalidId:	7680	Wh
MeterValuesAlignedData:	Current.Import,Energy.Active.Import.Register,Energy.Active.Imp	
MeterValuesAlignedDataMaxLength:	5	
MeterValuesSampledData:	Current.Import,Energy.Active.Import.Register,Temperature,Voltz	
MeterValuesSampledDataMaxLength:	4	
MeterValueSampleInterval:	900	Seconds
MinimumStatusDuration:	0	Seconds
NumberOfConnectors:	1	
ResetRetries:	0	Times
ConnectorPhaseRotation:	RST ▾	
ConnectorPhaseRotationMaxLength:	1	

OCPP1.6 Settings

These settings are defined and requested for support in OCPP 1.6 specification.

- **AllowOfflineTxForUnknownId** – If set to yes, an unknown ID (not in Authorization and Cache List) will be accepted and start the charging session when the charge point is not connected to the central system.
- **AuthorizationCacheEnabled** – If set to yes, the Authorization Cache is enabled.
- **AuthorizeRemoteTxRequests** – Whether a remote request to start a transaction in the form of a RemoteStartTransaction.req message should be authorized beforehand like a local action to start a transaction.
- **BlinkRepeat** – Number of times to blink the charge point lighting when signaling. This value is not changeable for AC19L/AC19L Exceed.
- **ClockAlignedDataInterval** – Length (in seconds) of the clock-aligned data interval. This is the length (in seconds) of the set of evenly spaced aggregation intervals per day, starting at 00:00:00 (midnight).
- **ConnectionTimeOut** – Interval until incipient charging session is automatically canceled due to failure of EV user to insert the charging cable connector(s) into the appropriate connector(s).
- **GetConfigurationMaxKeys** – Maximum number of requested configuration keys in a GetConfiguration.req PDU.

- **HeartBeatInterval** – Defines the heartbeat interval.
- **LightIntensity** – Percentage of maximum intensity at which to illuminate the charge point lighting. This value is not changeable for AC19L/AC19L Exceed.
- **LocalAuthorizeOffline** – Whether the charge point, when offline, will start a transaction for locally authorized identifiers.
- **LocalPreAuthorize** – Whether the charge point, when online, will start a transaction for locally authorized identifiers without waiting for or requesting an Authorize.conf from Central System.
- **MaxEnergyOnInvalidId** – Maximum energy in Watt-hour (Wh) delivered when an identifier is invalidated by Central System after the start of a transaction.
- **MeterValuesAlignedData** – Clock-aligned measurements to be included in a MeterValues.req PDU, every ClockAlignedDataInterval seconds. Supported values are Current, Import, Energy.Active.Import.Register, Temperature, Voltage, or any combination of these 4 values.
- **MeterValuesAlignedDataMaxLength** – Maximum number of items in a MeterValuesAlignedData configuration key.
- **MeterValuesSampledData** – Sampled measurands to be included in a MeterValues.req PDU, every MeterValueSampleInterval seconds. Supported values are Current.Import, Energy.Active.Import.Register, Temperature, Voltage, or any combination of these 4 values.
- **MeterValuesSampledDataMaxLength** – Maximum number of items in a MeterValuesSampledData configuration key.
- **MeterValueSampleInterval** – Interval between sampling of metering (or other) data, intended to be transmitted by “MeterValues” PDUs
- **MinimumStatusDuration** – The minimum duration that a charge point or connector status is stable before a StatusNotification.req PDU is sent to Central System.
- **NumberOfConnectors** – The number of physical charging connectors of this charge point.
- **ResetRetries** – Number of times to retry an unsuccessful reset of the charge point.

- **ConnectorPhaseRotation** – The phase rotation per connector in respect to the connector’s energy meter. Possible values per connector are:

NotApplicable (for single phase)

Unknown (not (yet) known)

RST (Standard Reference Phasing)

RTS (Reversed Reference Phasing)

SRT (Reversed 240 degree rotation)

STR (Standard 120 degree rotation)

TRS (Standard 240 degree rotation)

TSR (Reversed 120 degree rotation)

- **ConnectorPhaseRotationMaxLength** – Maximum number of items in a ConnectorPhaseRotation configuration key.

StopTransactionOnEVSideDisconnect:	<input type="button" value="Yes"/>	
StopTransactionOnInvalidId:	<input type="button" value="Yes"/>	
StopTxnAlignedData:	<input type="button" value=""/>	
StopTxnAlignedDataMaxLength:	<input type="text" value="0"/>	
StopTxnSampledData:	<input type="button" value=""/>	
StopTxnSampledDataMaxLength:	<input type="text" value="0"/>	
SupportedFeatureProfiles:	<input type="text" value="Core,Firmware Management,Local Auth List Management,Reservatio"/>	
SupportedFeatureProfilesMaxLength:	<input type="text" value="6"/>	
TransactionMessageAttempts:	<input type="text" value="10"/>	Times
TransactionMessageRetryInterval:	<input type="text" value="10"/>	Seconds
UnlockConnectorOnEVSideDisconnect:	<input type="button" value="Yes"/>	
WebSocketPingInterval:	<input type="text" value="180"/>	Seconds
LocalAuthListEnabled:	<input type="button" value="Yes"/>	
LocalAuthListMaxLength:	<input type="text" value="100"/>	
SendLocalListMaxLength:	<input type="text" value="100"/>	
ReserveConnectorZeroSupported:	<input type="button" value="Yes"/>	
ChargeProfileMaxStackLevel:	<input type="text" value="99"/>	
ChargingScheduleAllowedChargingRateUnit:	<input type="text" value="Current"/>	
ChargingScheduleMaxPeriods:	<input type="text" value="32"/>	
ConnectorSwitch3to1PhaseSupported:	<input type="button" value="No"/>	
MaxChargingProfilesInstalled:	<input type="text" value="10"/>	

- **StopTransactionOnEVSideDisconnect** – When set to true, the charge point SHALL administratively stop the transaction when the cable is unplugged from the EV.
- **StopTransactionOnInvalidId** – Whether the charge point will stops an on-going transaction when it receives a non-accepted authorization status in a StartTransaction.conf for this transaction.

- **StopTxnAlignedData** – Clock-aligned periodic measurand(s) to be included in the TransactionData element of StopTransaction.req MeterValues.req PDU for every ClockAlignedDataInterval of the charging session. Supported values are Current.Import, Energy.Active.Import.Register, and Temperature, Voltage, or any combination of these 4 values.
- **StopTxnAlignedDataMaxLength** – Maximum number of items in a StopTxnAlignedData configuration key.
- **StopTxnSampledData** – Sampled measurands to be included in the TransactionData element of StopTransaction.req PDU, every MeterValueSampleInterval seconds from the start of the charging session. Supported values are Current.Import, Energy.Active.Import.Register, Temperature, Voltage, or any combination of these 4 values.
- **StopTxnSampledDataMaxLength** – Maximum number of items in a StopTxnSampledData configuration key.
- **SupportedFeatureProfiles** – A list of supported Feature Profiles. Possible profile identifiers: Core, FirmwareManagement, LocalAuthListManagement, Reservation, SmartCharging and RemoteTrigger.
- **SupportedFeatureProfilesMaxLength** – Maximum number of items in a SupportedFeatureProfiles configuration key.
- **TransactionMessageAttempts** – How often the charge point should try to submit a transaction-related message when Central System fails to process it.
- **TransactionMessageRetryInterval** – How long the charge point should wait before resubmitting a transaction-related message that Central System failed to process.
- **UnlockConnectorOnEVSideDisconnect** – When set to true, the charge point SHALL unlock the cable on the charge point side when the cable is unplugged at the EV. This is not supported by AC19L/AC19L Exceed since it is a plug type and has no connector lock.
- **WebSocket Ping Interval** – Define the ping pong interval for WebSocket protocol.
- **LocalAuthListEnabled** – Whether the Local Authorization List is enabled.
- **LocalAuthListMaxLength** – Maximum number of identifications that can be stored in the Local Authorization List.
- **SendLocalListMaxLength** – Maximum number of identifications that can be sent in a single SendLocalList.req.

- **ReserveConnectorZeroSupported** – If this configuration key is present and set to true: The charge point supports reservations on connector 0.
- **ChargeProfileMaxStackLevel** – Max Stack Level of a Charging Profile. The number defined also indicates the max allowed number of installed charging schedules per Charging Profile purposes.
- **ChargingScheduleAllowedChargingRateUnit** – A list of supported quantities for use in a Charging Schedule. This value will always be 'Current' for AC19L/AC19L Exceed.
- **ChargingScheduleMaxPeriods** – Maximum number of periods that may be defined per Charging Schedule.
- **ConnectorSwitch3to1PhaseSupported** – If defined and true, this charge point supports switching from 3 to 1 phase during a charging session. This field is read-only.
- **MaxChargingProfilesInstalled** – Maximum number of charging profiles installed at a time.

5.3.4 Communication Settings

Clicking on the “**Configuration**” and then “**Communication Settings**” link will bring up the following screen. Since the page is too long to display, it is here separated into multiple screens.

On this page, you can set up the network connection. To finish, click the “**Apply**” button.

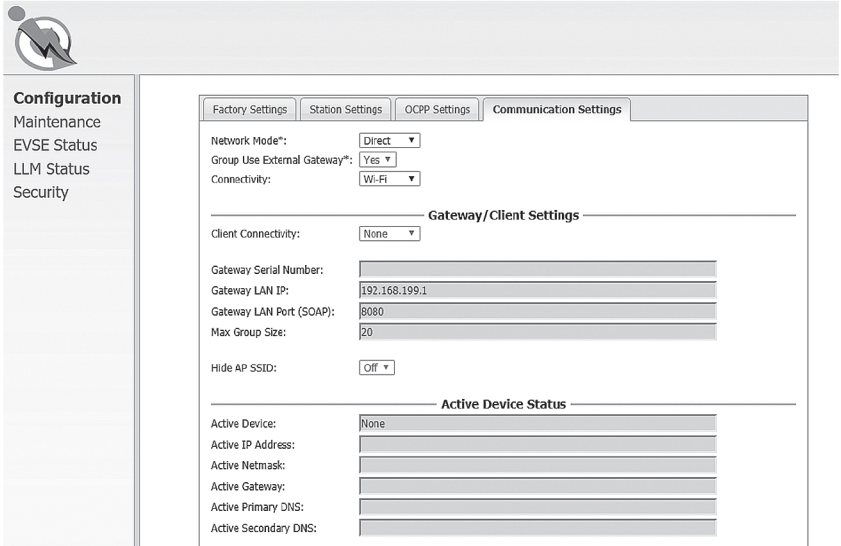

Configuration

- Maintenance
- EVSE Status
- LLM Status
- Security

Factory Settings Station Settings OCPP Settings **Communication Settings**

Network Mode*: ▾
Group Use External Gateway*: ▾
Connectivity: ▾

Gateway/Client Settings

Client Connectivity: ▾

Gateway Serial Number:

Gateway LAN IP:

Gateway LAN Port (SOAP):

Max Group Size:

Hide AP SSID: ▾

Active Device Status

Active Device:

Active IP Address:

Active Netmask:

Active Gateway:

Active Primary DNS:

Active Secondary DNS:

- **Network Mode** – Specifies if the Local Proxy function has been enabled. Available options are **Gateway**, **Client** and **Direct**.

1. **Direct**: Use the charge point as a single device.
2. **Gateway**: Use the charge point as a gateway charge point. When the Gateway is connected to OCPP 1.6 Server via cellular or Wi-Fi and connected to other charge points (called Clients) via Wi-Fi, it will form and forms a local group of charge points. This group is also a LAN (Local Area Network).
3. **Client**: Use the charge point as a client charge point. Connect the Client connected to Gateway via Wi-Fi. If the Client is connected to OCPP1.6 Server through gateway charge point (via cellular or Wi-Fi), Gateway will dispatch incoming remote command to proper client charge points (or Gateway itself).

- **Group Use External Gateway** – Gateway/Client mode use external gateway as a local network group or not (use Gateway IC).

NOTE

A Gateway charge point can choose using Wi-Fi/Cellular/Ethernet to connect to the internet by changing the 'Group Use External Gateway' setting. If set to Yes, a Gateway will use Cellular/Wi-Fi/Ethernet. When changed this setting, the 'Connectivity' option will automatically change as well.

All charge points in this Gateway/Client group must have the same 'Group Use External Gateway' setting, i.e. all charge points must set this option to Yes (including Gateway and Client) when we want to use an external Wi-Fi AP to connect to the internet. In this case, all charge points must also use the same Wi-Fi settings (SSID, password) for the external Wi-Fi AP.

If you want to change the web portal setting of Direct, Gateway and Client mode, please refer to the separate address of the web portal.

Direct / Gateway charge point : 10.10.0.1

Client charge point : 10.10.0.2

- **Connectivity** – Specifies whether the charge point should always be connected to the Internet using **None**, **Auto**, **Wi-Fi**, or **Cellular**. The default value is Auto. (Cellular: or AC19L Exceed only) The rules for the options are defined as below:
 1. None/Auto/Ethernet/Wi-Fi/Cellular for IC-Direct
 2. Ethernet/Wi-Fi for IC-Gateway (Group Use External Gateway = Yes)
 3. Wi-Fi/Cellular for IC-Gateway (Group Use External Gateway = No)
 4. Wi-Fi for SC-Direct/SC Plus-Direct
 5. Ethernet/Wi-Fi for IC-Client/SC Plus-Client
- **Client Connectivity** – Specifies whether the Gateway Device should always be connected to the Client Device using Ethernet or Wi-Fi.
- **Gateway Serial Number** – The serial number of the charge point which acts as a Gateway.

- **Gateway LAN IP** – The IP of the LAN master. This value cannot be modified by users.
- **Gateway LAN Port (SOAP)** – The listen port for OCPP SOAP client server. This value cannot be modified by users.
- **Hide AP SSID** – Options for whether to hide the SSID of the charge point. For AC19L/AC19L Exceed this option is always off.

There are four kinds of **Gateway/Client Network Topologies** as below:

1. Topology#1 Ethernet

All Gateway/Client EVSE in a group that can connect to the Internet via **Ethernet**.

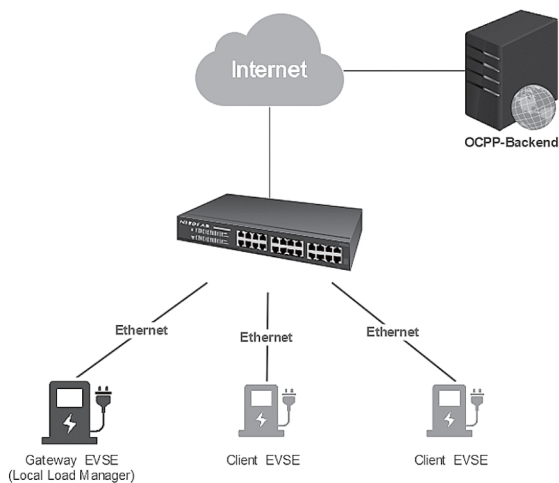

Setting up each EVSE according to the following settings:

Settings	Gateway	Client
Network Mode	Gateway	Client
Group Use External Gateway	Yes	Yes
Connectivity	Ethernet	Ethernet
Client Connectivity	None	None
Gateway Serial Number	Gateway Serial Number	Gateway Serial Number

2. Topology#2 Wi-Fi

All Gateway/Client EVSE in a group that can connect to the Internet via Wi-Fi.

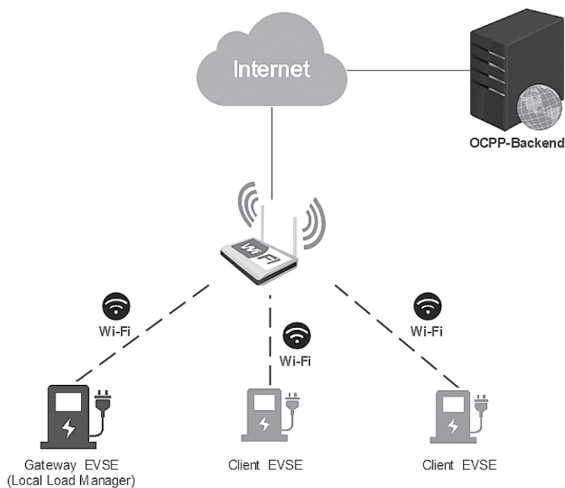

Setting up each EVSE according to the following settings:

Settings	Gateway	Client
Network Mode	Gateway	Client
Group Use External Gateway	Yes	Yes
Connectivity	Wi-Fi	Wi-Fi
Client Connectivity	None	None
Gateway Serial Number	Gateway Serial Number	Gateway Serial Number

3. Topology#3 Wi-Fi/Cellular + Ethernet

The Gateway EVSE in a group that can connect to the Internet via **Wi-Fi** or **Cellular**. The Client EVSE in a group that can connect to the Gateway EVSE via **Ethernet**.

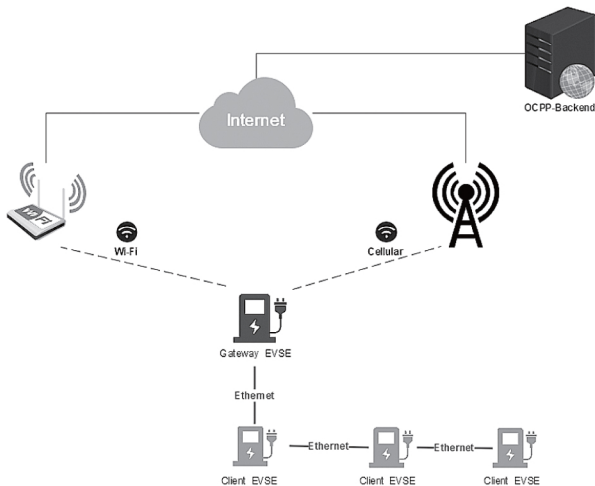

Setting up each EVSE according to the following settings:

Settings	Gateway	Client
Network Mode	Gateway	Client
Group Use External Gateway	No	No
Connectivity	Wi-Fi/Cellular	Ethernet
Client Connectivity	Ethernet	None
Gateway Serial Number	Gateway Serial Number	Gateway Serial Number

4. Topology#4 Wi-Fi/Cellular + Wi-Fi

The Gateway EVSE in a group that can connect to the Internet via **Wi-Fi**, or **Cellular**. The Client EVSE in a group that can connect to the Gateway EVSE via **Wi-Fi**.

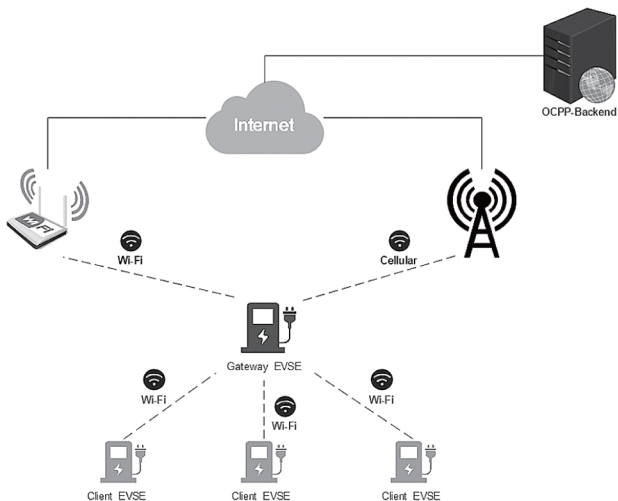

Setting up each EVSE according to the following settings:

Settings	Gateway	Client
Network Mode	Gateway	Client
Group Use External Gateway	No	No
Connectivity	Wi-Fi/Cellular	Wi-Fi
Client Connectivity	Wi-Fi	None
Gateway Serial Number	Gateway Serial Number	Gateway Serial Number

Active Device Status

- **Active Device** – Current active network device. Possible values are None, Wi-Fi or Cellular
- **Active IP Address** – Current active IP address. There will be a value here only if connected to a network.
- **Active Netmask** – Current active netmask address. There will be a value here only if connected to a network.
- **Active Gateway** – Current active gateway IP address. There will be a value here only if connected to a network and the network provides this data.
- **Active Primary DNS** – Current active primary DNS IP address. There will be a value here only if connected to a network and the network provides this data.
- **Active Secondary DNS** – Current active secondary DNS IP address. There will be a value here only if connected to a network and the network provides this data.

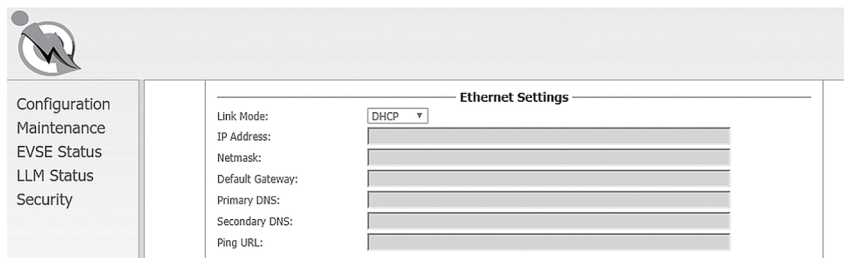

The screenshot shows a user interface for configuring Ethernet settings. On the left is a vertical navigation menu with options: Configuration, Maintenance, EVSE Status, LLM Status, and Security. The main area is titled "Ethernet Settings" and contains several fields: "Link Mode" with a dropdown menu currently set to "DHCP", "IP Address", "Netmask", "Default Gateway", "Primary DNS", "Secondary DNS", and "Ping URL". Each of these fields has a corresponding empty text input box to its right.

Ethernet Settings

- **Link Mode** – Configure the Ethernet port to use DHCP or Static IP. If you select Static IP from the drop-down menu, you need to enter values for IP Address, Netmask, and Default Gateway fields.
- **IP Address** – The IP address of the charge point. It's modifiable if Link Mode is Static IP.
- **Netmask** – The subnet mask. It's modifiable if Link Mode is Static IP.
- **Default Gateway** – The default gateway. It's modifiable if Link Mode is Static IP.
- **Primary DNS** – The primary Domain Name Server (optional).
- **Secondary DNS** – The secondary Domain Name Server (optional).
- **Ping URL** – Address of the host that the charge point will ping for the Ethernet connection (optional).



Configuration
Maintenance
EVSE Status
LLM Status
Security

Wi-Fi Settings	
SSID:	<input type="text"/> <input type="button" value="Scan"/>
Security:	<input type="text" value="WPA2-PSK"/>
Password:	<input type="text"/>
Wi-Fi MAC Address:	<input type="text" value="d0:5f:b8:1b:8d:e7"/>
Wi-Fi Signal Strength:	<input type="text"/> dBm

Wi-Fi Settings

- **SSID** – The SSID name of the Wi-Fi Access Point. Press Scan to scan and receive current detectable Wi-Fi signals.
- **Security** – The encryption of the Wi-Fi Access Point. Options are None, WEP, WPA-PSK, WPA2-PSK, WPA-PSK+WPA2-PSK and Auto.
- **Password** – The password of the Wi-Fi Access Point.
- **Wi-Fi MAC Address** – Displays the Wi-Fi device hardware MAC address.
- **Wi-Fi Signal Strength** – Displays the strength of the wireless Wi-Fi signal in percentage (%).



Configuration
Maintenance
EVSE Status
LLM Status
Security

Cellular Settings

MNC:	
ICCID:	
IMSI:	
IMEI:	866425037797620
MEID:	866425037797620
Cellular APN:	
Cellular APN User:	
Cellular APN Password:	
Cellular Dial Number:	*99#
Cellular PIN Code:	
Primary DNS:	
Secondary DNS:	
Cellular Signal Strength:	

dBm

Cellular Settings (Support only on AC19L Exceed)

- **MNC** – The Mobile Network Code of the cellular service provider. There will be no data here if there is no 3G/LTE signal.
- **ICCID** – The ICCID of the modem's SIM card. There will be no data here if no SIM card is inserted.
- **IMSI** – The IMSI of the modem's SIM card. There will be no data here if no SIM card is inserted.
- **IMEI** – The IMEI (International Mobile Equipment Identity) of the modem.
- **MEID** – The MEID (Mobile Equipment Identifier) of the modem.
- **Cellular APN** – This is the gateway for all cellular traffic. Contact your cellular operator for information about this. For AT&T and Verizon LTE service, just leave it blank since the apn name is built into the modem.
- **APN Username** – This is the user name your ISP has assigned to you (optional).
- **APN Password** – Password to log into the ISP network (optional).
- **Dial Number** – Phone number to dial for cellular network.
- **PIN Code** – PIN code for the modem's SIM card (optional). 4 digit number.
- **Primary DNS** – The primary Domain Name Server (optional).
- **Secondary DNS** – The secondary Domain Name Server (optional).
- **Cellular Signal Strength** – The strength of the cellular signal in dBm.

Local Load Management(LLM) Settings

Local Load Management™:	<input type="text" value="Disable"/>
Charging Policy™:	<input type="text" value="Uniform Distribution"/>
Group ID:	<input type="text"/>
Group Size:	<input type="text" value="1"/>
Max Amperage Grid Connection:	<input type="text" value="100"/> Amps
Fallback Current:	<input type="text" value="6.0"/> Amps

Local Load Management (LLM) Settings (Support only on AC19L Exceed)

Local load management is the process of balancing the supply of electricity on the network with the electrical load by adjusting or controlling the load of each charge point in a local group based on Gateway/Client architecture. The Gateway AC19L Exceed must be manually set to the maximum current limitations so that it will dynamically adjust output current in each Client AC19L Exceed according to charging policy.

When the LLM function is on, all charge points will request charging from Gateway, and Gateway will calculate the proper current limit and reply to each Client. Each charge point will only allow charging once it receives a current limit from Gateway. If there is a disconnection between a Client and Gateway, then the Client will use a fallback value as the limitation.

- **Local Load Management** – Enable or disable the Local Load Management function. This function can only be enabled in a **Gateway** or **Client** charge point.

HINT: If the user changes the “Network Mode” settings, then related settings will also change automatically. This includes “Connectivity”, “Local Load Management”. The default value is as follows:

	Direct	Gateway	Client
Gateway LAN IP	Not used	Default value, not changeable	Not used
Gateway LAN Port	Not used	Default value, not changeable	Not used
Max Group Number	Not used	Default value, not changeable	Not used
Group Use External Gateway	Not used	Yes or No	Yes or No
Gateway Serial Number	Not used	Not used	Used
Connectivity	Auto	Wi-Fi or Cellular	Wi-Fi, not changeable
Local Load Management	Disabled, not changeable	Enable	Enable

- **Charging Policy** – The charging policy for LLM Gateway to decide the charging current for each charge point. Valid options are:

1. UD (default): Uniform Distribution. The maximum amperage is divided by the total numbers of charging EVs, i.e. each EV will use the same charging current.
2. FIFS: First In First Serve.

- **Group ID** – An identity of the LLM group. A slave with a different group identity will be rejected when attempting to connect to Gateway.
- **Group Size** – The total number of charge points in the LLM group. This value is only used in Gateway.
- **Max Amperage Grid Connection** – Total ampere of each phase allowed loading for the group of charge points at the same time. This value is only used in Gateway.
- **Fallback Current** – The fallback current when the Client is not able to communicate with Gateway. Gateway will overwrite fallback current in Client with its own value when Client connects to Gateway

NOTE

Any option followed by an asterisk (*) means the setting requires a reboot to take effect. When these values are changed and applied, the web portal will display a reminder message box for rebooting the charge point.

The screenshot shows a web portal interface with a sidebar on the left containing menu items: Configuration, Maintenance, EVSE Status, LLM Status, and Security. The main content area is titled 'Service Settings' and contains various configuration fields. A modal dialog box titled 'Message' is overlaid on the page, displaying the text: 'Please reboot the system since starred setting(s) changed. Do you want to reboot now?' with 'Yes' and 'No' buttons. Below the dialog, the 'Apply' button is visible. The configuration fields include:

- Charge Point ID: EX-1762-1A31-18-13-EM003
- Protocol Name: ocpp1.6j
- Central System URL*: ws://192.168.1.144:3333
- Basic Auth ID*:
- Basic Auth Password*:
- FTP Server Username: ftpuser
- FTP Server Password:
- Message Transport Layer: WS
- Boot Notification:
- Boot Notification:
- PDU Timeout:
- Download Firm:
- Download Firm:
- Upload Diagnostic Interval: 300
- Upload Diagnostic Retries: 3

Below the 'Service Settings' section, there is an 'OCPP1.6 Settings' section with the following fields:

- AllowOfflineTxForUnknownId: Yes
- AuthorizationCacheEnabled: Yes

5.4 Maintenance

This page includes some maintenance functions.

5.4.1 Reboot

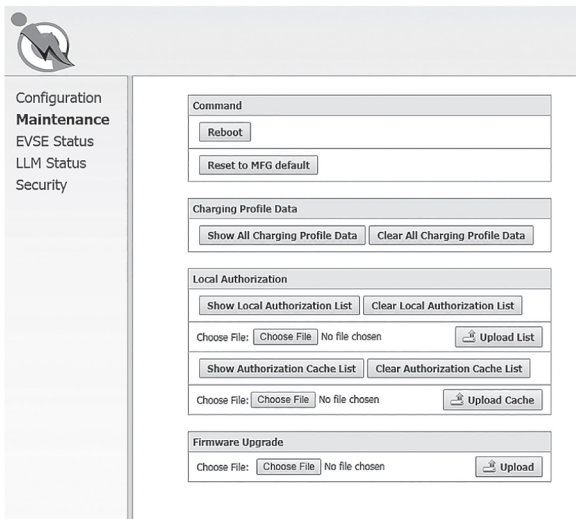

Command

- **Reboot:** To restart the charge point.
- **Reset to MFG default:** To reset to the factory default settings.

Charging Profile Data

HINT: Charging Profile is defined in OCPP 1.6 specification for smart charging. A charging profile consists of a charging schedule, which is basically a list of time intervals with their maximum charge power or current, and some values to specify the time period and recurrence of the schedule.

- **Show All Charging Profile Data:** To show the list of Charging Profiles. There will be a display window. The data display here is RAW data, usually for diagnostic use.
- **Clear All Charging Profile Data:** To clear all Charging Profile data.

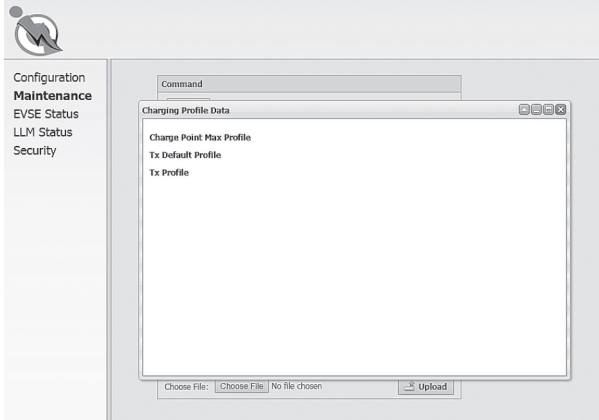

Local Authorization

HINT: Local authorization is defined in OCPP 1.6 specification. There are two local list: Local Authorization List and Authorization Cache List. The Local Authorization List is a list of identifiers that can be synchronized with the Central System. An Authorization Cache autonomously maintains a record of previously presented identifiers that have been successfully authorized by the Central System.

- **Show Local Authorization List:** To show the list of Local Authorization. Each line of the list shown below indicates RFID card info. The syntax is `CARD_IDTAG|EXPIRY_DATE|PARENT_CARD_IDTAG|CARD_STATUS`

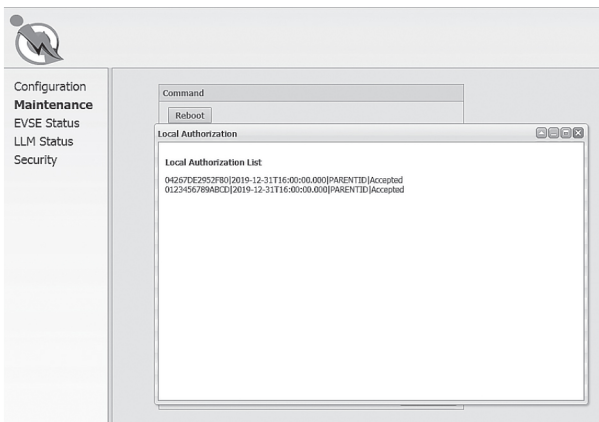

- **Clear Local Authorization List:** To clear the list of Local Authorization.
- **Upload List:** Upload a csv file that includes card info to Local Authorization List.

A csv file is a plain text file in which each line represents an RFID card's information. The format of a card info is as follow:

CARD_IDTAG,EXPIRY_DATE,PARENT_CARD_IDTAG,CARD_STATUS

CARD_IDTAG: 8 ~ 20 alphanumeric character RFID card ID tag.

EXPIRY_DATE: The date when the idTag should be removed from the Authorization Cache. Format is YYYY-MM-DDThh:mm:ss.ttt which indicates a date in AD.

Example: 2019-12-31T16:00:00.000

PARENT_CARD_IDTAG: The parent-identifier of the card. The format is the same as CARD_IDTAG.

CARD_STATUS: This contains whether the idTag has been accepted or not by the Central System. Valid options are Accepted, Blocked, Expired or Invalid. This string is case sensitive.

Sample data: 0123456789ABCD,2019-12-31T16:00:00.000,PARENTID,Accepted

- **Show Authorization Cache List:** To show the list of the Authorization Cache. Each line of the list shown below indicates cached RFID card info. The syntax is

CARD_IDTAG|EXPIRY_DATE|PARENT_CARD_IDTAG|CARD_STATUS|
 CACHED_DATE

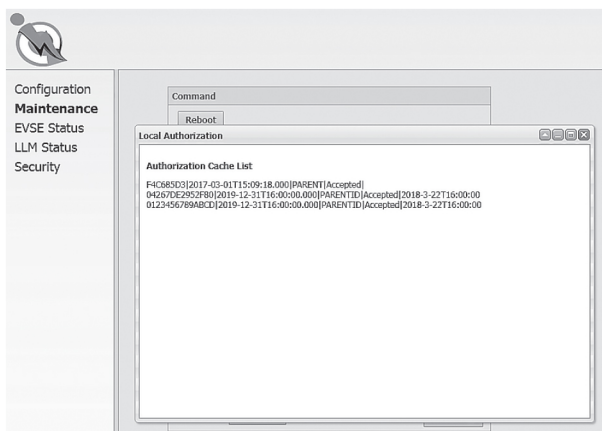

- **Clear Authorization Cache List:** To clear the Authorization Cache list.
- **Upload Cache:** Upload a csv file that includes cached card info to Authorization Cache List.

A csv file is a plain text file which each line represent a cached RFID card info. The format of a cached card info is as follow:

**CARD_IDTAG,EXPIRY_DATE,PARENT_CARD_IDTAG,CARD_STATUS,-
CACHED_DATE**

CARD_IDTAG: 8 ~ 20 alphanumeric character RFID card ID tag.
 EXPIRY_DATE: The date when the idTag should be removed from the Authorization Cache. Format is YYYY-MM-DDThh:mm:ss.ttt which indicates a date in AD.
 Example: 2019-12-31T16:00:00.000
 PARENT_CARD_IDTAG: the parent-identifier of the card. The format is the same as CARD_IDTAG.
 CARD_STATUS: This contains whether the idTag has been accepted or not by the Central System. Valid options are **Accepted**, **Blocked**, **Expired** or **Invalid**. This string is case sensitive.
 CACHED_DATE: The date when the idTag will be cached. The format is identical to EXPIRY_DATE.
 Sample data: 0123456789ABCD,2019-12-31T16:00:00.000,PARENTID,Accepted,2018-3-22T16:00:00

Sample data: 0123456789ABCD,2019-12-31T16:00:00.000,PARENTID,Accepted,2018-3-22T16:00:00

5.4.2 Firmware Upgrade

To upgrade the firmware of the charge point, you need to download the upgrade image file to your local hard disk, and then click the **“Choose File”** button to locate the firmware file on your computer. Once you have selected the new firmware file, click the **“Upload”** button to start the upgrade process. After a successful upgrade, the web portal will be logged out and the charge point will reboot.

Although the web portal does not forbid uploading firmware of a previous version, the design of each firmware upgrade file includes all backward modifications. Downgrading the firmware may cause unpredicted problems and is not recommended.

5.5 EVSE Status

To check the specific information of EVSE, you can click the corresponding buttons:

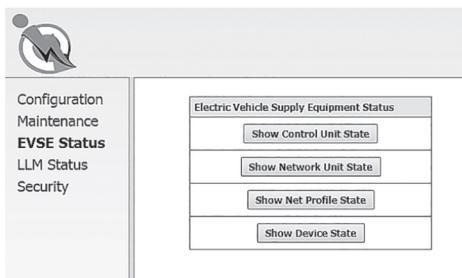

- **Show Control Unit State:** To display the information of the control unit of the charge point. These functions mostly relate to charging and safety.
- **Show Network Unit State:** To display the information of the network board of the charge point. These functions mostly relate to network connection and remote management.
- **Show Net Profile State:** To display the information of the network connectivity and settings of charge point.
- **Show Device State:** To display the information of the device service/connection between the charge point and OCPP server/network connectivity.

5.6 LLM Status (AC19L Exceed support only)

5.6.1 LLM information

This page shows the Local Load Management information for the charge point. For further description of LLM, please refer to section 5.6.3.

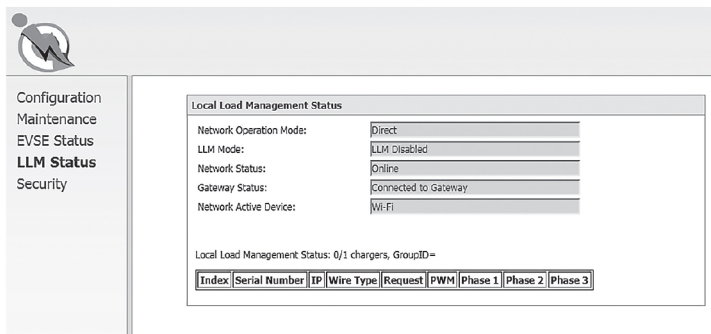

Configuration
Maintenance
EVSE Status
LLM Status
Security

Local Load Management Status

Network Operation Mode: Direct
LLM Mode: LLM Disabled
Network Status: Online
Gateway Status: Connected to Gateway
Network Active Device: Wi-Fi

Local Load Management Status: 0/1 chargers, GroupID=

Index	Serial Number	IP	Wire Type	Request	PWM	Phase 1	Phase 2	Phase 3
-------	---------------	----	-----------	---------	-----	---------	---------	---------

- **Network Operation Mode:** Indicates that the charge point is in Direct mode, a Gateway or a Client.
- **LLM Mode:** Indicates that the Local Load Management function is enabled or disabled.
- **Network Status:** Indicates whether the charge point is online.
- **Gateway Status:** Indicates whether the charge point is connected to the Gateway if it's a Client. For Direct and Gateway, it always shows "Connected to Gateway".
- **Network Active Device:** Indicates which device the network is connected through. It could be Offline, Wi-Fi or Cellular.
- **Local Load Management Status:** Display connected charge points, total charge points, Group ID of the LLM group, and a full table of detailed information for charge point if this charge point is Gateway.

5.6.2 Gateway/Client group table

If the charge point is Gateway, the following LLM Group Table is present.

Configuration
Maintenance
LLM Status
Security
OQCTest

Local Load Management Status: 20/20 chargers, GroupID=

Index	Serial Number	IP	Wire Type	Request	PWM	Phase 1	Phase 2	Phase 3
1	04000023	192.168.199.62	L1 L2 L3	32.0	32.0	15.1	0.7	0.8
2(M)	04000080	10.81.19.91	L1 L2 L3	32.0	32.0	13.7	0.7	0.8
3	04000026	192.168.199.33	L3 L1 L2	0.0	0.0	0.0	0.0	0.0
4	04000046	192.168.199.50	L1 L2 L3	32.0	32.0	0.0	0.0	0.0
5	04000070	192.168.199.51	L3 L1 L2	32.0	32.0	0.0	0.0	0.0
6	04000092	192.168.199.57	L2 L1 L3	32.0	32.0	0.0	0.0	0.0
7	04000071	192.168.199.49	L2 L1 L3	0.0	0.0	0.0	0.0	0.0
8	04000090	192.168.199.48	L1 L2 L3	32.0	32.0	0.0	0.0	0.0
9	04000032	192.168.199.47	L3 L1 L2	0.0	0.0	0.0	0.0	0.0
10	04000050	192.168.199.52	L1 L2 L3	32.0	32.0	14.3	0.1	0.1
11	04000064	192.168.199.46	L2 L1 L3	32.0	32.0	0.5	15.7	0.3
12	04000024	192.168.199.58	L2 L1 L3	0.0	0.0	0.0	0.0	0.0
13	04000027	192.168.199.56	L2 L1 L3	32.0	32.0	0.5	15.0	0.5
14	04000020	192.168.199.54	L3 L1 L2	32.0	32.0	5.0	0.6	0.6
15	04000054	192.168.199.61	L3 L1 L2	32.0	32.0	14.4	0.7	0.7
16	04000036	192.168.199.63	L1 L2 L3	32.0	32.0	0.5	0.5	0.5
17	04000082	192.168.199.59	L3 L1 L2	0.0	0.0	0.0	0.0	0.0
18	04000049	192.168.199.64	L2 L1 L3	0.0	0.0	0.0	0.0	0.0
19	04000079	192.168.199.55	L1 L2 L3	32.0	32.0	0.0	0.0	0.0
20	04000076	192.168.199.60	L1 L2 L3	32.0	32.0	0.8	0.9	0.9

Total: Request: 448.0 A, PWM: 448.0 A, Phase1: 64.8 A, Phase2: 34.9 A, Phase3: 5.2 A

- **Index:** The order of the charge points. The first charge point shown is Gateway.
- **Serial Number:** The serial number (Charge Point Identity) of each charge point.
- **IP:** The private local IP address in the LLM group of each charge point.
- **Wire Type:** The power source wire type of each charge point.
- **Request:** The requested current of each charge point.
- **PWM:** The PWM (charger allowed) current of each charge point.
- **Phase 1, Phase 2, Phase 3:** The real current loaded by the vehicles of each charge point. For AC19L Exceed, only Phase 1 has current.

5.6.3 Operation mode

There are two different operation modes: **Distribution mode** and **Priority mode**. Each time a new car is plugged-in and starts charging, the LLM gateway will re-calculate the proper ampere for each charging station.

Depending upon the operation mode, the algorithm is different.

Distribution mode (Uniform Distribution)

The available current is divided equally amongst all available charging stations.

Example 1

In this example, there are three (32 A) charging stations in the LLM group. Each charging station is set up according to the following settings:

Setting	Gateway	Client
Local Load Management	Enable	Enable
Charging Policy	Uniform Distribution	Not used
Group ID	LLM-Group-1	LLM-Group-1 (Same as Gateway)
Group Size	3	Not used
Max Amperage Grid Connection	60	Not used
Fallback Current	10	10 (Same as Gateway)

With one connected vehicle, the charging current is 32 A.

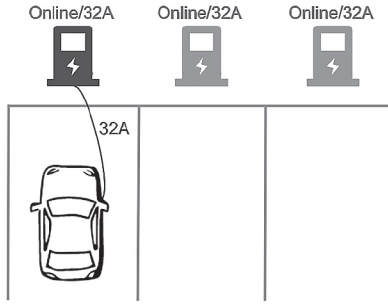

With two connected vehicles, the charging currents are evenly reduced to 30 A.

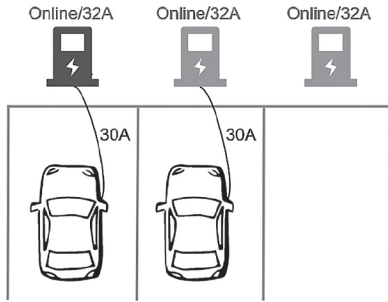

With three connected vehicles, the charging currents are further reduced to 20 A.

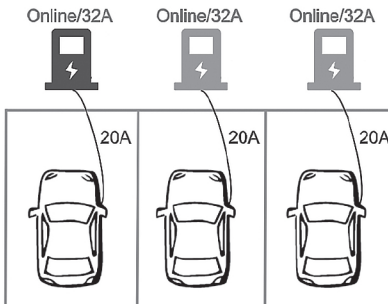

Example 2

In this example, there are two (32 A) charging stations and one (16 A) charging station in the LLM group. Each charging station is set up according to the following settings:

Setting	Gateway	Client
Local Load Management	Enable	Enable
Charging Policy	Uniform Distribution	Not used
Group ID	LLM-Group-1	LLM-Group-1 (Same as Gateway)
Group Size	3	Not used
Max Amperage Grid Connection	60	Not used
Fallback Current	10	10 (Same as Gateway)

With one connected vehicle, the charging current is 32 A.

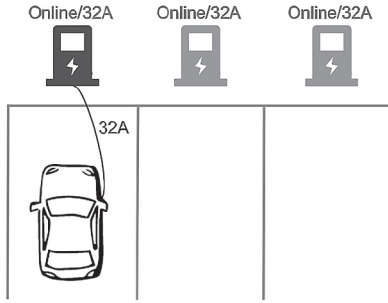

With two connected vehicles, the charging currents are evenly reduced to 30 A.

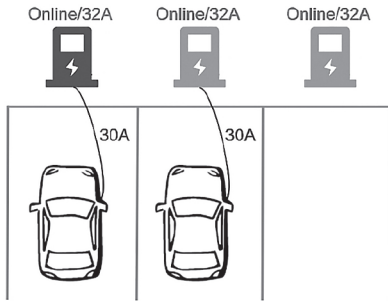

With three connected vehicles, the charging currents are further reduced to 24 A for the 32 A charging stations and 12 A for the 16 A charging station.

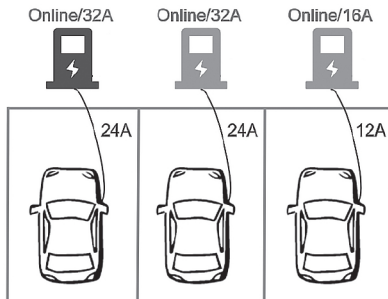

Example 3

In this example, there are five (32 A) charging stations in the LLM group, and two of the charging stations are offline. Each charging station is set up according to the following settings:

Setting	Gateway	Client
Local Load Management	Enable	Enable
Charging Policy	Uniform Distribution	Not used
Group ID	LLM-Group-1	LLM-Group-1 (Same as Gateway)
Group Size	5	Not used
Max Amperage Grid Connection	80	Not used
Fallback Current	10	10 (Same as Gateway)

With one connected vehicle, the charging current is 32 A. (Reserve 20 A for offline charging stations)

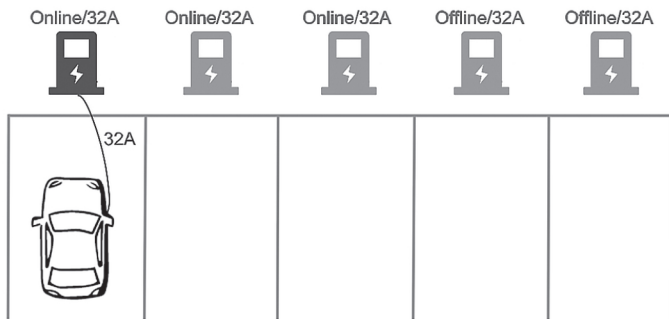

With two connected vehicles, the charging currents are evenly reduced to 30A. (Reserve 20A for offline charging stations)

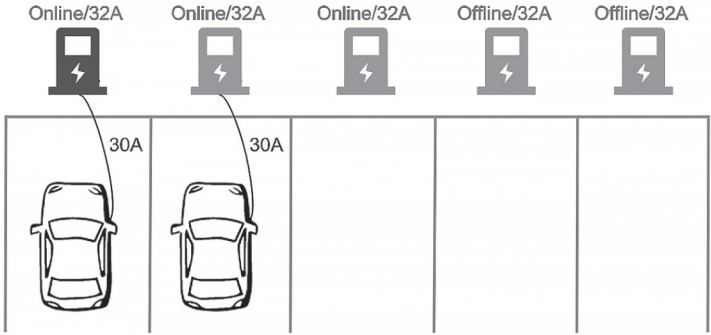

With three connected vehicles, the charging currents are further reduced to 20A. (Reserve 20A for offline charging stations)

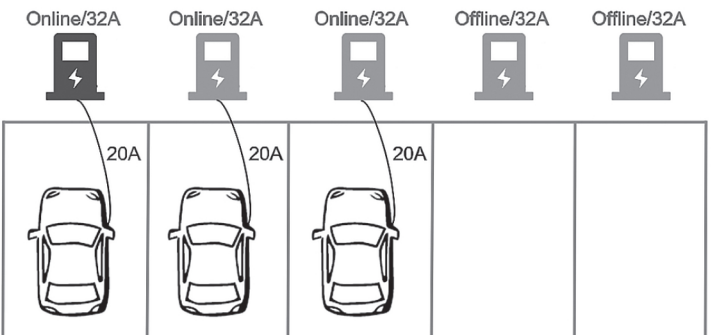

Priority mode (First Come First Serve)

The available current is NOT divided equally amongst all available charging stations. The first vehicle connected would be allocated as much as possible. If any current capacity is left, then the remainder would be given to the other charging stations.

Example 1

In this example, there are three (32 A) charging stations in the LLM group. Each charging station is set up according to the following settings:

Setting	Gateway	Client
Local Load Management	Enable	Enable
Charging Policy	First In First Serve	Not used
Group ID	LLM-Group-1	LLM-Group-1 (Same as Gateway)
Group Size	3	Not used
Max Amperage Grid Connection	60	Not used
Fallback Current	10	10 (Same as Gateway)

The first vehicle connected receives 32 A.

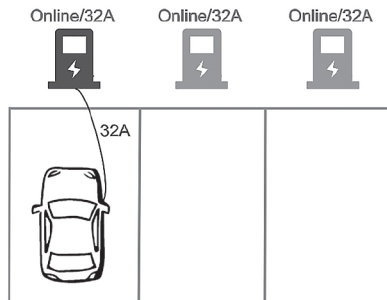

The second vehicle would receive 28A.

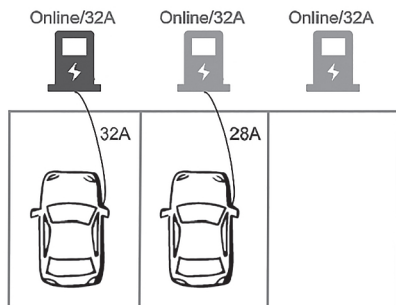

The third vehicle is NOT able to receive current.

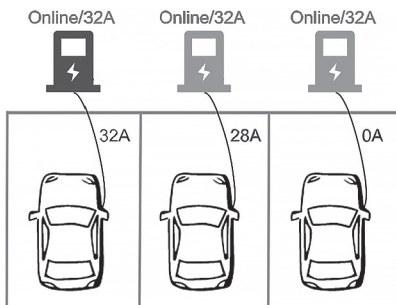

When the first vehicle leaves, the second vehicle receives 32 A, and the third vehicle would receives 28 A.

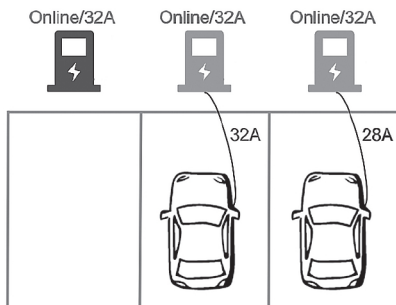

Example 2

In this example, there are five (32 A) charging stations in the LLM group and two of the charging stations are offline. Each charging station is set up according to the following settings:

Setting	Gateway	Client
Local Load Management	Enable	Enable
Charging Policy	First In First Serve	Not used
Group ID	LLM-Group-1	LLM-Group-1 (Same as Gateway)
Group Size	5	Not used
Max Amperage Grid Connection	100	Not used
Fallback Current	10	10 (Same as Gateway)

The first vehicle connected would receives 32 A. (Reserve 20A for offline charging stations)

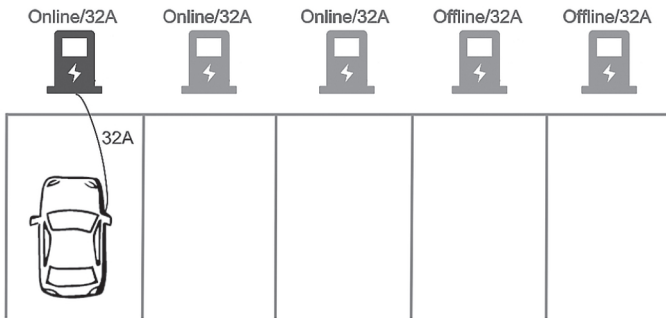

The second vehicle receives 32 A. (Reserve 20 A for offline charging stations)

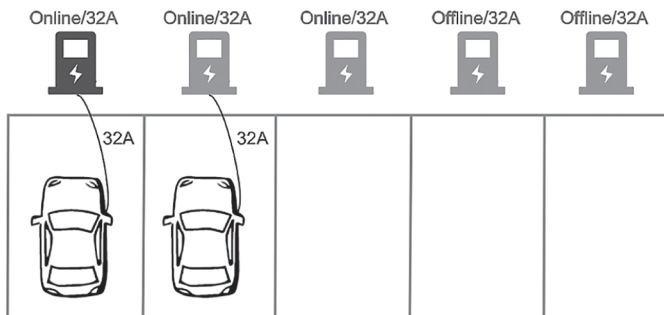

The third vehicle receives 16 A. (Reserve 20 A for offline charging stations)

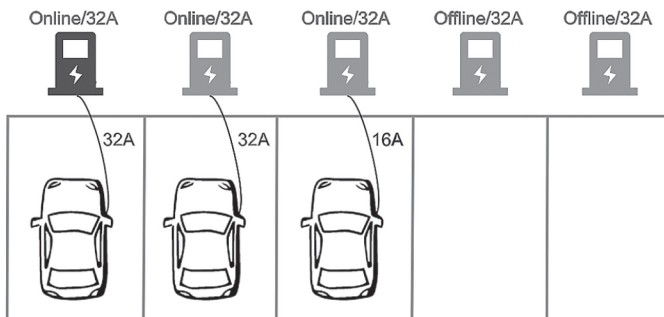

5.7 Security

5.7.1 Change password

To change the password, first choose the user whose password you want to change. There are two default users – **admin** and **maintain**. Only admin users can access the Security Page. Enter the old password and the new password then press “**Apply**” to change the user’s password.

To reset the password of all users, press “**Reset password of all users**”.

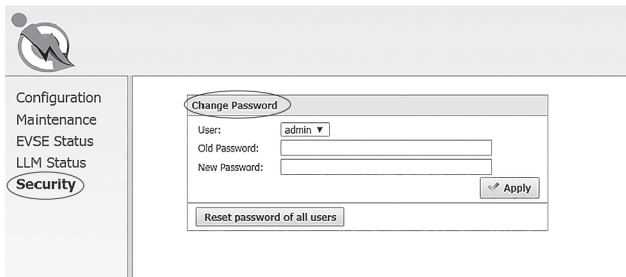

6. Activation Instructions

6.1 Activation Overview



Prior to activation, make sure to collect the necessary information for the site and charging station owner. Each charger has a visible Station ID QR code on it.

- Scan either of the codes to begin the activation process through our web portal.
 1. Enter the project code provided by Noodoe EV or your Charge Point Operator. If you do not have one, create a site. (see 6.3)
 2. Confirm or add station ID. (see 6.4)
 3. Upload photos of the charging station. (see 6.5)

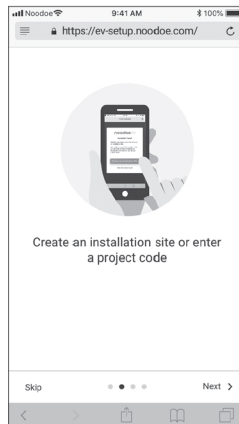
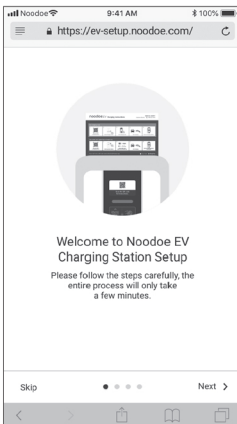

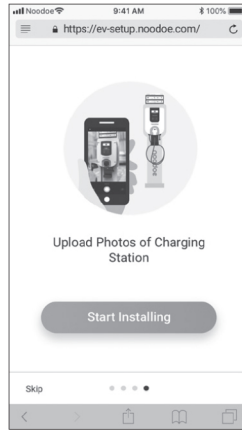
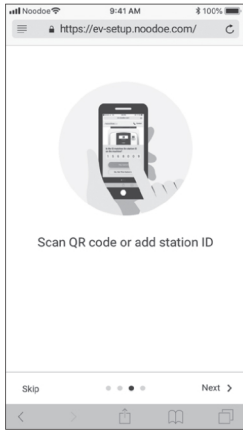

6.2 Prior to Activation

Before starting, collect the following information:

- Site Details
 1. Address
 2. Phone number
- Charging Station Owner's Credentials
 1. Full name
 2. Email address
 3. Phone number
- NOTE: The Charging Station Owner is responsible for setting prices, collecting revenue, and ensuring that the subscription service to Noodoe EV OS is paid for.

6.3 Creating a Site

If you have a project code provided either by Noodoe EV or your charge point operator, use that to begin the process. If there is no code, choose “Create an Installation Site” to begin activation.

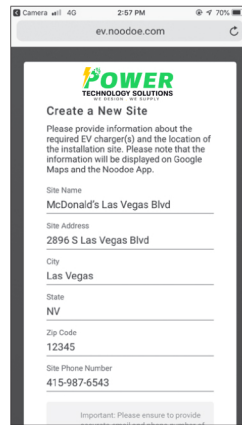
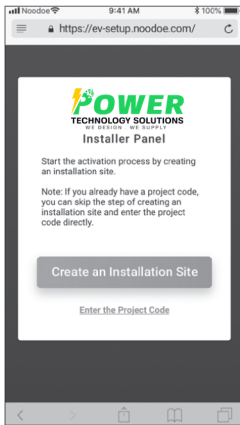

Site & Owners Information

- To finalize site creation, you will need a few pieces of information. Make sure you have all of this information before moving ahead with the activation procedure.
- Site Information:
 1. Site name
 2. Site address
 3. Site phone number
- Station Owner's Information
 1. Charging Station Owner's name
 2. Charging Station Owner's email address
 3. Charging Station Owner's phone number
- Installer information
- NOTE: This site information will be used on a charger location map, so it must be accurate. Additionally, the Charging Station Owner of the site will be responsible for managing the chargers, receiving payments made through them, and paying the subscription fees for Noodoe EV OS.

6.4 Adding Charging Stations

Make sure the stations are powered up and the site has been created in the setup program.

- Add each station one by one.
 1. Add stations by scanning their QR codes OR
 2. Add stations using their Station IDs

6.5 Taking Charging Station Photos

Photos are important for helping EV drivers find your charging stations. Take a photo of each station to be used in Google Maps and in the Noodoe App.

Photo Suggestions:

- Take closeups of each charger (with the QR code visible).
- Include pictures taken from a distance so drivers can see the parking environment.
- State parking instructions where necessary or useful.

7. Operations

7.1 Charging Status Indicators

Description	Definition
Not illuminated	Power Off
Green Steady	Ready
Green Flashing	Flashing green (Fast): Authorized, wait for the EV to connect Flashing green (Slow): Suspend (Occupying)
Blue Flashing	Flashing blue (Slow): Charging
Red Steady	Unrecoverable Fault
Red Flashing	Recoverable Fault
Purple Steady	Reserved (from OCPP Service)
Yellow Flashing	Booting / Firmware Upgrading / Out of Service

7.2 Authorization (for AC19L Exceed Only)

Before the owner of an electric vehicle can start or stop charging, the Charge point has to authorize the operation.

7.2.1 Online Authorization

Description:

- Generally, before the owner of an electric vehicle can start or stop charging, the EVSE has to authorize the operation. The EVSE SHALL only supply energy after authorization.

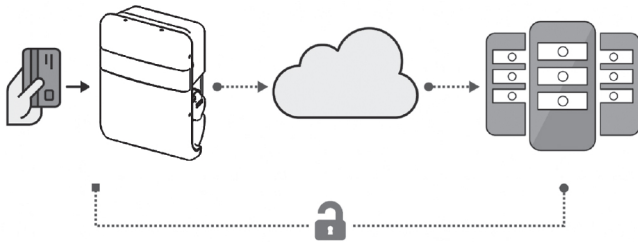

7.2.2 Local Authorization

Description:

- Synchronized with the Central System when EVSE is Online.
- To improve the experience for users, the EVSE MAY support local authorization when EVSE is offline, and a faster authorization response time when communication between the charge point and Central System is slow.

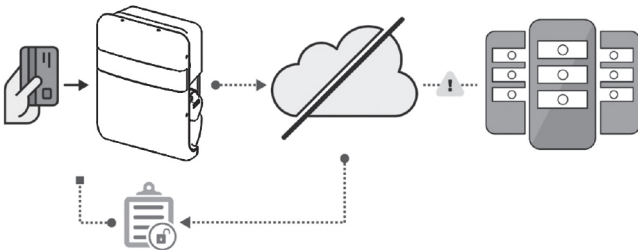

7.3 Charging an Electric Vehicle (EV)

Choices for how to start charging are as below:

7.3.1 Plug and Charge

1. Insert the charging plug into the EV
2. Begin the charging session

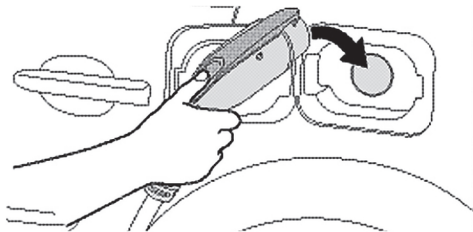

Connect the charging plug to the EV

7.3.2 RFID card (for AC19L Exceed Only)

1. Insert the charging plug into the EV
2. Swipe your card
3. Wait for the authorization
4. Begin the charging session

7.4 Stop charging

1. Unplug any time (disconnect the charging plug from the EV to stop the charging session)
2. Session ended (please return the connector to the holster)

7.4.1 Interrupt charging

Please refer to the STOP CHARGING section for more information.

7.4.2 Auto restart

When a charging session is interrupted due to a temporary error condition, the charge point will automatically restart charging when the cause of the temporary error condition returns to normal. Status indicator lights will keep flashing RED until the error condition is resolved.

- Temporary error conditions include: Over Current, Over Voltage, Under Voltage, and Over Temperature.
- For Over Current conditions: The charging session will be stopped while OC occurs. 30 seconds after recovery from OC, the charge point will automatically restart charging three times.
- When charging session stopped due to CCID trip, the charge point will try to restart after 15 minutes for 3 times.

7.4.3 Power outage recovery

When power resumes after an outage, the charge point restarts automatically with a delay ranging from 120 to 720 seconds. The delay is designed to avoid impacting the utility grid when multiple charge points are in the same area attempting to resume charging simultaneously.

7.5 General care

The exterior of the charge point is designed to be waterproof and dust proof. To ensure proper maintenance of the charge point, follow these guidelines:

- Despite the water resistance of the enclosure, when cleaning it is preferred to not direct streams of water at the unit. Clean with a soft, damp cloth.
- Make sure the charging plug is put back in the holster after charging to avoid damage.
- Ensure the power cable is stored on the charge point after use to avoid damage.
- If the power cable or the charging plug is damaged, please contact Customer Support.

7.6 Customer Support

Please contact your reseller directly for technical support.

8. Federal Communication Commission Interference Statement

This device complies with Part 15 of the FCC Rules. Operation is subject to the following two conditions: (1) This device may not cause harmful interference, and (2) this device must accept any interference received, including interference that may cause undesired operation. This equipment has been tested and found to comply with the limits for a Class B digital device, pursuant to Part 15 of the FCC Rules. These limits are designed to provide reasonable protection against harmful interference in a residential installation. This equipment generates, uses and can radiate radio frequency energy and, if not installed and used in accordance with the instructions, may cause harmful interference to radio communications. However, there is no guarantee that interference will not occur in a particular installation. If this equipment does cause harmful interference to radio or television reception, which can be determined by turning the equipment off and on, the user is encouraged to try to correct the interference by one of the following measures:

- Reorient or relocate the receiving antenna.
- Increase the separation between the equipment and receiver.
- Connect the equipment into an outlet on a circuit different from that to which the receiver is connected.
- Consult the dealer or an experienced radio/TV technician for help.

FCC Caution: Any changes or modifications not expressly approved by the party responsible for compliance could void the user's authority to operate this equipment.

This transmitter must not be co-located or operating in conjunction with any other antenna or transmitter.

Radiation Exposure Statement:

This equipment complies with FCC radiation exposure limits set forth for an uncontrolled environment. This equipment should be installed and operated with a minimum distance 20 cm between the radiator and your body.

9. Industry Canada Statement

This device complies with ISED's licence-exempt RSSs. Operation is subject to the following two conditions: (1) This device may not cause harmful interference, and (2) this device must accept any interference received, including interference that may cause undesired operation.

Le présent appareil est conforme aux CNR d'ISED applicables aux appareils radio exempts de licence. L'exploitation est autorisée aux deux conditions suivantes : (1) le dispositif ne doit pas produire de brouillage préjudiciable, et (2) ce dispositif doit accepter tout brouillage reçu, y compris un brouillage susceptible de provoquer un fonctionnement indésirable.

Radiation Exposure Statement:

This equipment complies with ISED radiation exposure limits set forth for an uncontrolled environment. This equipment should be installed and operated with a distance greater than 20 cm between the radiator and your body.

Déclaration d'exposition aux radiations:

Cet équipement est conforme aux limites d'exposition aux rayonnements ISED établies pour un environnement non contrôlé. Cet équipement doit être installé et utilisé à plus de 20 cm entre le radiateur et votre corps.

This device is intended only for OEM integrators under the following conditions: (For module device use)

- (1) The antenna must be installed and operated with a distance greater than 20 cm between the antenna and users, and
- (2) The transmitter module may not be co-located with any other transmitter or antenna.

As long as both conditions above are met, further transmitter tests will not be required. However, the OEM integrator is still responsible for testing their end-product for any additional compliance requirements required with this module installed.

Cet appareil est conçu uniquement pour les intégrateurs OEM dans les conditions suivantes: (Pour utilisation de dispositif module)

- (1) L'antenne doit être installé et exploité avec plus de 20 cm entre l'antenne et les utilisateurs, et
- (2) Le module émetteur peut ne pas être coïmplanté avec un autre émetteur ou antenne.

Tant que les 2 conditions ci-dessus sont remplies, des essais supplémentaires sur l'émetteur ne seront pas nécessaires. Toutefois, l'intégrateur OEM est toujours responsable des essais sur son produit final pour toutes exigences de conformité supplémentaires requis pour ce module installé.

IMPORTANT NOTE:

In the event that these conditions cannot be met (for example certain laptop configurations or co-location with another transmitter), then the Canada authorization is no longer considered valid and the IC ID cannot be used on the final product. In these circumstances, the OEM integrator will be responsible for re-evaluating the end product (including the transmitter) and obtaining a separate Canada authorization.

NOTE IMPORTANTE:

Dans le cas où ces conditions ne peuvent être satisfaites (par exemple pour certaines configurations d'ordinateur portable ou de certaines co-localisation avec un autre émetteur), l'autorisation du Canada n'est plus considéré comme valide et l'ID IC ne peut pas être utilisé sur le produit final. Dans ces circonstances, l'intégrateur OEM sera chargé de réévaluer le produit final (y compris l'émetteur) et l'obtention d'une autorisation distincte au Canada.

10. Maintenance and Repair

10.1 Daily Maintenance

Please keep the charger in a clean area with low humidity. Do not install it in an environment near the sea, with high oil, high humidity or high quantities of dust.

- Avoid moisture or water in the charger. If there is water or moisture ingress into the charger, it is necessary to immediately power off to avoid immediate danger and to notify professional support personnel to carry out maintenance before next use.
- If there is any damage or dirt on the vehicle connector, charging cable, or vehicle connector holder, please contact maintenance personnel immediately.
- Please use the charger properly. Do not hit or press hard on the case. If the case is damaged, please contact a professional technician.
- Avoid placing the charger near hot objects or in high temperature locations, and keep it away from dangerous substances such as flammable gases and corrosive materials.
- Do not place external objects or heavy objects on the charger to avoid danger.

10.2 Maintenance Supplies

This product is equipped with adequate spare maintenance parts for regular maintenance use under and over the warranty period. Warranty services and repairs must be performed by company certified maintenance technicians. For details, please contact the charger distributor or customer service of the company.



Please visit the official website to obtain the latest version of the user manual before installation.

Website: www.noodoe.com