



# AC11P Exceed User Manual



Dust and Water  
Protection MEMA 4



Authorization



Management



Easy  
Maintenance



Easy Installation

# CONTENTS

Introduction/User Experience /Noodoe EV Operating System (EV OS)/	
Autonomous Revenue Generation .....	2
Pricing/User Management/Extensibility .....	3
<b>1. Important Safety Instructions .....</b>	<b>4</b>
<b>2. Interface .....</b>	<b>6</b>
2.1 Basic Interface .....	6
2.2 Bottom Case and Wire box .....	7
<b>3. Dimensions (Unit: mm) .....</b>	<b>8</b>
3.1 Main Size of Charger .....	8
3.2 Wall-Mount Bracket .....	8
<b>4. Specifications .....</b>	<b>9</b>
<b>5. Status Description of the Charger Indication Lights .....</b>	<b>10</b>
<b>6. Screen Instructions .....</b>	<b>11</b>
6.1 Status bar .....	11
6.2 Status Code Table .....	11
<b>7. Installation Instructions .....</b>	<b>13</b>
7.1 Safty Requirements .....	13
7.2 Power Grid Connection and Grounding Type .....	14
7.3 Packing List .....	16
7.4 Tools and Materials Required .....	17
7.5 Wall-Mount Bracket Installation Requirements .....	17
7.6 Installation Requirements .....	18
7.7 Steps for Installation .....	18
7.8 Gateway Installation .....	27
7.9 Gateway Installation Scenario .....	28
<b>8. Charger Standard Setting .....</b>	<b>29</b>
8.1 Time setting .....	29
8.2 Wi-Fi Setup .....	31
8.3 4G Setup (for the Optional 4G Edition) .....	32
8.4 Re-checking the Wi-Fi and 4G Signal Strength on Power-Up .....	33
<b>9. Operating Instructions .....</b>	<b>35</b>
9.1 Error and Warning Message .....	37
<b>10. Activation Instructions .....</b>	<b>39</b>
10.1 Activation Overview .....	39
10.2 Prior to Activation .....	40
10.3 Creating a Site.....	41
10.4 Adding Charging Stations.....	42
10.5 Taking Charging Station Photos.....	42
<b>11. Federal Communication Commission Interference Statement .....</b>	<b>43</b>
<b>12. Industry Canada Statement .....</b>	<b>44</b>
<b>13. Maintenance and Repair .....</b>	<b>46</b>
13.1 Daily Maintenance .....	46
13.2 Maintenance Spares .....	46

# Introduction

Noodoe EV AC chargers offer convenience and efficiency to both customers and service providers. These charging stations feature simple installation and management. AC chargers are easy additions to any location and are highly requested by EV-driving customers. They are excellently suited to retail and commercial parking lots, workplaces, restaurants, multi-unit dwellings, and anywhere else looking to provide a smooth, convenient charging experience. Noodoe EV AC chargers are sturdy and can stand up to the elements. They are safety certified, and the design is both waterproof and dustproof. Install them anywhere without environmental concerns.

## User Experience

The Noodoe EV AC Exceed charger is easy to engage with and use. It features a simple design to make charging a truly painless experience. Drivers need only scan, plug in, and charge. No annoying memberships or app downloads are necessary. Users can begin charging either through an authorized RFID smart card (perfect for office staff or apartment buildings), the Noodoe mobile app, or our online web portal.

## Noodoe EV Operating System (EV OS)

Noodoe EV OS is a cloud-based operating system that unifies the management of all Noodoe EV charging stations. It centralizes charger operation and streamlines the administration of the entire charging network. The EV OS dashboard pulls together information from every connected charger, providing a wealth of information right at your fingertips. Revenue generation becomes practically hands-free as EV OS implements your chosen settings. It even runs charging station diagnostics and self-repair protocols, dramatically reducing the need for expensive maintenance and repairs.

## Autonomous Revenue Generation

- Noodoe EV OS supports autonomous revenue generation by streamlining all aspects of EV charger management.
- Service providers have access to up-to-the-minute data on usage, monetization, power status, and more.

- Noodoe EV AC chargers support universal, automatic pay-at-the-pump transactions through Apple Pay, Google Pay, credit cards, or the membership management program in Noodoe EV OS.
- Funds automatically transfer to the management-designated account.

## **Pricing**

- Connect chargers from multiple sites to a shared network in Noodoe EV OS, enabling pricing changes right from the EV OS dashboard.
- Change pricing and availability on the fly or via pre-set, automated schedules with the click of a button.
- Set pricing based on either time taken (price per minute) or energy usage (price per kW).
- Enjoy set-it-and-forget-it automatic peak hour price changes.

## **User Management**

- Chargers can offer multiple pricing tiers through EV OS's integrated user management system.
- Users can make payments through at-the-pump mobile transactions or targeted membership plans for VIPs, special guests, residents, or staff.
- Membership management allows for charging to be available to a select few as a free amenity while still requiring payment by the wider public.
- Integrated user management is ideal for staff and fleet charging, leaving unused chargers available for public use.

## **Extensibility**

- Noodoe EV offers additional software services specially developed for a wide range of charging environments, including those for fleets, workplaces, residences, shopping centers, dealerships, gas stations, smart cities, and more.
- To support the different needs of our customers, Noodoe EV AC chargers support intelligent load balancing, distributing power across multiple chargers on the same network.
- Noodoe EV load balancing means more chargers can be installed on the same site without costly site upgrades.

# 1. Important Safety Instructions

Please read all Important Safety Instructions as well as charging instructions in your vehicle owner's manual before attempting to charge your electric vehicle. Failure to do so can result in severe injury or death. Save this user manual for future reference. There are many safety features built into the charger. Read all the safety information and warnings in this manual to be avoid any risks or hazards and risks associated with using this charger.



## Warning

When using electric products, basic precautions should always be followed. This manual contains important instructions, including the following, that must be followed during installation, operation and maintenance.

- Do not install or use the charger near flammable, explosive, corrosive, or combustible materials, chemicals, or vapors.
- Turn off the input power of the charger before performing any maintenance to the charger.
- The device is designed only for vehicles that are compatible with the SAE J1772 charging standard.
- Do not use the charger if it is defective, appears cracked, frayed, broken or damaged.
- Do not attempt to open, disassemble, repair, tamper with, or modify the charger. Contact our Customer Service department if you have any questions or require any parts replacements or repairs.
- Do not use the charger when you are, the vehicle is, or the charger is exposed to severe rain, snow, or other severe weather.
- When transporting the charger, handle it with care. Do not drag, or step on the device.
- Do not touch the charging connector terminal with any sharp metallic objects to prevent damage.
- Do not forcefully pull the charging cable, damage it with sharp objects, put fingers, or insert foreign objects into any part of the charging connector.

- Risk of explosion. This device has arcing or sparking parts that should not be exposed to flammable vapors.
  - Risk of electric shock. Do not remove the cover or attempt to open the enclosure of this device. There are no user-serviceable parts inside. Contact a qualified service company if you require any service repairs.
  - To reduce the risk of fire, connect only to a circuit provided with 60 amperes maximum branch circuit overcurrent protection in accordance with the national Electrical Code, ANSI/NFPA 70, and the Canadian Electrical Code, Part I, C22.1
  - This charger should be installed, adjusted, and serviced by a qualified electrician or a person familiar with the construction and operation of this type of charger and the dangers involved. Failure to observe this precaution could result in damage to the charger or even severe injury or death.
  - Incorrect installation and testing of the charger could potentially damage either the vehicle's battery or the charger. This type of damage is not covered by our warranty policy.
  - Ensure that the charging cable is well-positioned during the charging process to avoid the cable getting stepped on, tripped over, or subjected to damage or stress.
  - Do not use this charger with a frayed charging cable with damaged insulation or any other sign of damage.
  - Ensure the wire type, diameter, current rating, and temperature rating comply with the local electrical standards and requirements in your local area.
  - Before starting the installation, turn off all power.
  - For Permanently connected equipment, Protective grounding and bonding terminals - Field wiring terminals for connection of equipment-grounding conductors are identified by: "G," "GR," "GND," "Ground," "Grounding" or the ground symbol or on a wiring diagram provided on unit, or a marking on wiring diagram attached to the unit.
- \* This device should be supervised when used around children.
- \* Do not put fingers into the electric vehicle connector.
- \* The device is not to be lifted or carried by either the flexible cord or the EV cable.

# 2. Interface

## 2.1 Basic Interface

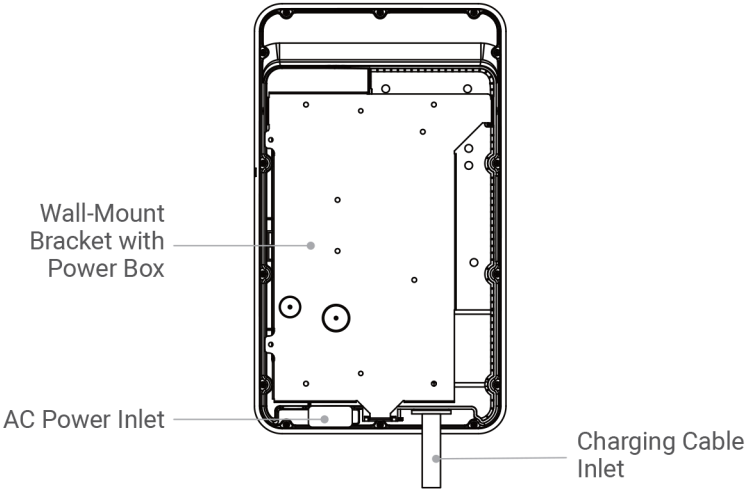
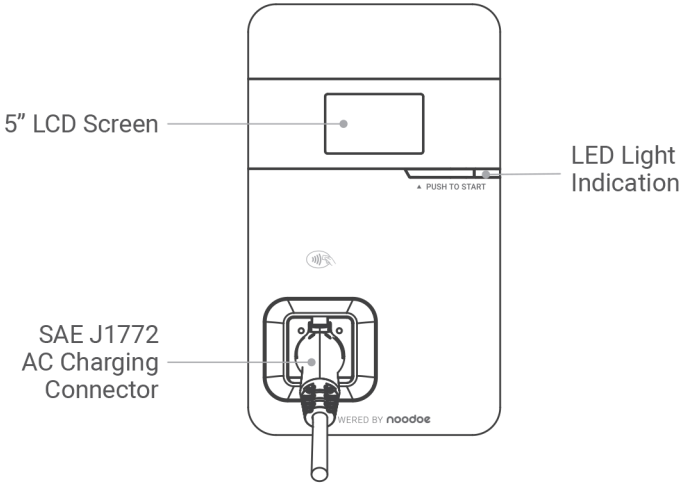

## 2.2 Bottom Case and Wire box

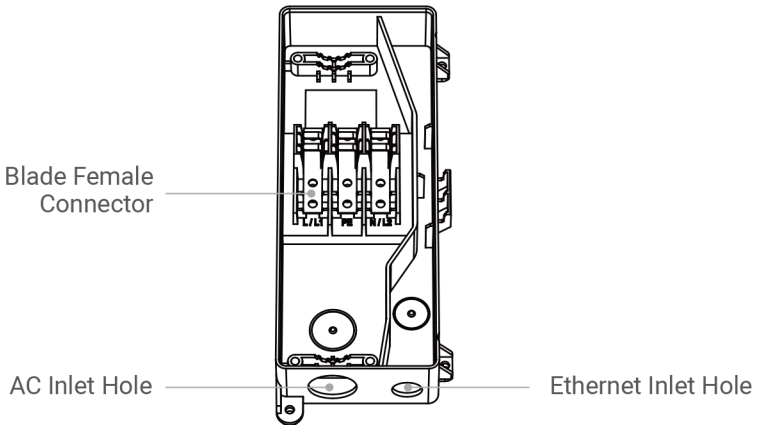
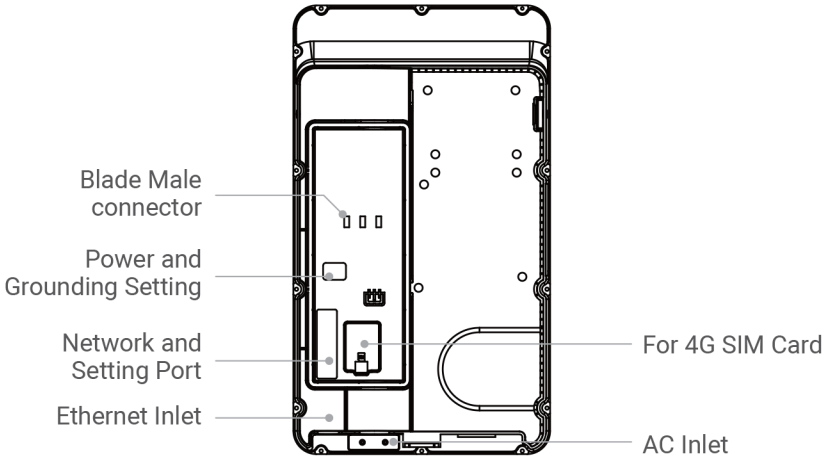



### 3. Dimensions (unit:mm)

#### 3.1 Main Size of Charger

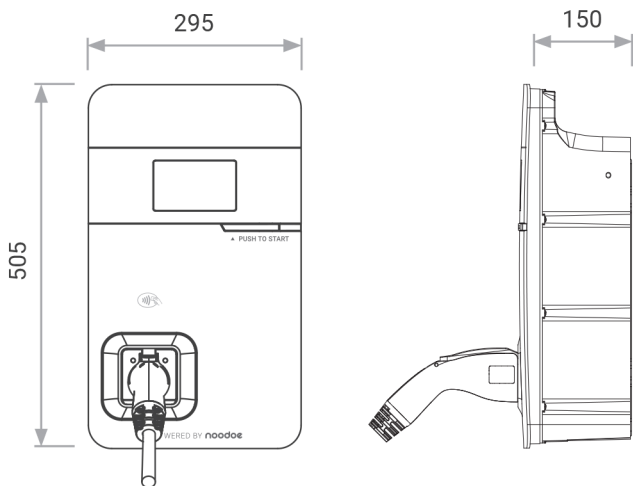

#### 3.2 Wall-Mount Bracket

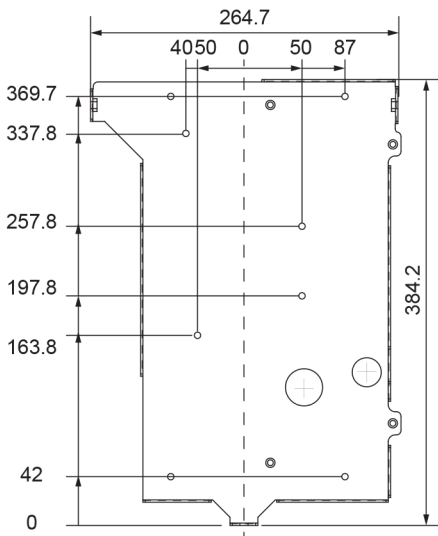

## 4. Specifications

Model Name	AC11P Exceed
Rated Input Voltage	200-240 Vac, 1-phase
Rated Output Current	48 A
AC Power Frequency	50/60 Hz
Input Protection	UVP, OVP, Surge protection, Ground fault protection
Output Protection	OCP, Control pilot fault, Residual current protection
Output Interface	SAE J1772 AC Charging Connector
Storage Temperature	-40 °C to +70 °C
Operation Temperature	-30 °C to +50 °C
Relative Operation Humidity	Up to 85% at 50 °C non-condensing
Relative Storage Humidity	Up to 95% at 50 °C non-condensing
Display	5-inch LCD
User Authorization	RFID (ISO/IEC 14443A/B, ISO/IEC 15693, FeliCa™, Mifare), ISO15118
RJ45 Cable Inlet*	10 M/100 M Base-T
Wi-Fi Function*	802.11 b/g/n
3G/4G Function*	LTE, UMTS/HSPA(+)
Cable Length	5 m (From charger's body to lower edge of charging connector)
Protection Level	NEMA TYPE 4
Installation Type	Wall-Mount
Altitude	≤ 2000 m
Weight	9 ± 0.5 kg
Dimensions	295 (W) x 150 (D) x 505 (H) mm
Certifications	UL, ENERGY STAR, CTEP

\*4G Version

## 5. Status Description of the Charger Indication Lights







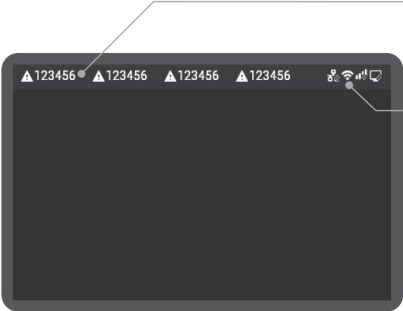



Work status	Blue	Green	Red
Initial	Constantly Bright (White)		
Idle Backend connected Sleep	-	Breath	-
Idle Backend connected	-	Constantly Bright	-
Idle Backend disconnected Sleep	-	Breath (Yellow)	
Idle Backend disconnected	-	Constantly Bright (Yellow)	
Authorize RFID authorization Pass		Flicker 3 sec	
Authorize RFID authorization Fail			Flicker 3 sec
Handshaking	Constantly Bright	-	-
Charging	Flicker	-	-
Terminate	Constantly Bright	-	-
Complete	Constantly Bright	-	-
Maintenance Upgrade	-	Flicker (Yellow)	
Reservation	-	Flicker	

# 6. Screen Instructions

## 6.1 Status Bar



Status Code

-  Ethernet connected with internet
-  Ethernet connected without internet
-  Ethernet not connected
-  Wi-Fi connected with internet
-  Wi-Fi connected without internet
-  Wi-Fi not connected
-  4G connected with internet
-  4G connected without internet
-  4G not connected
-  Backend online
-  Backend offline

## 6.2 Status Code Table

\*For the latest status code, please visit our website.

Status Code	Description
011004	RCD/CCID self-test fail
011009	output relay welding
011010	output relay driving fault
011021	Wi-Fi module broken
011022	3G/4G module broken

Status Code	Description
011036	Rotary switch fault
012200	System input OVP
012203	System input UVP
012212	System input drop
012216	System output OCP
012223	System ambient/inlet OTP
012233	RCD/CCID trip
012241	Wi-Fi module communication fail
012242	3G/4G module communication fail
012243	RFID module communication fail
012254	Fail to create shared memory
012255	CSU initialization failed
012256	Ground Fault
012257	MCU self-test Fault
012262	System output Circuit Short
012344	Meter IC communication timeout
012345	Pilot negative error
013607	CSU firmware update fail
013622	Disconnected from Internet through Ethernet
013623	Disconnected from Internet through W-iFi
013624	Disconnected from Internet through 3G/4G
013625	Disconnected from AP through W-iFi
013626	Disconnected from APN through 3G/4G
023703	Pilot fault

# 7. Installation Instructions

## 7.1 Safety Requirements

- Read this user manual thoroughly and make sure to review all local building and electrical codes before installing the AC charger. A qualified technician should install the AC charger according to the user manual and local safety regulations.
- Use appropriate protection when connecting to the main power distribution cable.
- Type B, C or D breaker with a rating current of 60 Amp should be installed in the upstream AC distribution box.
- Disconnect switch for each ungrounded conductor of AC input shall be provided by others in accordance with the National Electric Code, ANSI/ NFPA 70.
- Verify that the Wall Connector is properly grounded. The Ground connection must be bonded in the upstream power supply for proper operation. Check all physical connections, including the wirebox terminals, electrical panel(s), and wire box. In residential power supplies, check the bond between Ground and neutral at the main panel. If connected to a step-down transformer, contact the transformer's manufacturer for direction on how to bond the ground connection.

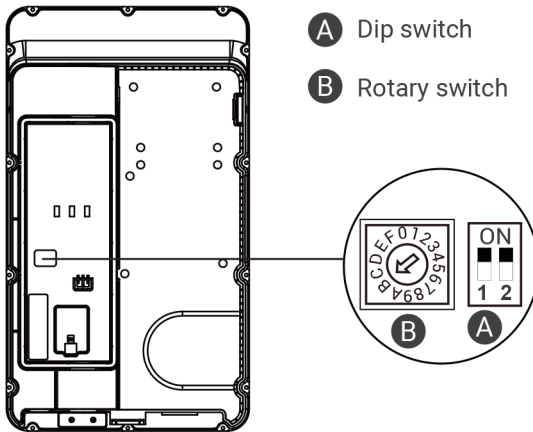

## 7.2 Power Grid Connection and Grounding Type

- This AC charger supports different power grid connections and grounding types. You can configure through the setting dip switch. Setting methods are shown below.
- Before setting the dip switch, make sure the input power is turned OFF.
- Use a non-conductive object to set the dip switch.

	Switch 1 (Power Grid Type)	Switch 2 (Grounding System)
ON	LN	IT
OFF	LL	TT-TN

Charger input terminal

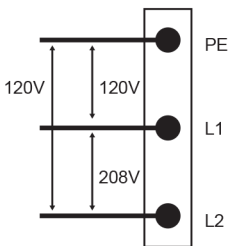

Charger input terminal

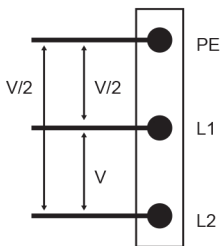

V=240 or 200 volt



Charger input terminal

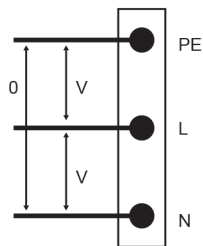

V=240 or 230 or 220 or 200 volt



\* Note 1: The default value in North America and Japan is (LL / TT-TN).

\* Note 2: The default value for other regions is (LN / TT-TN).

\* Note 3: If it is not the above standard grid type, please contact our technical staff for assistance and confirmation.

## Maximum Output Current

This AC charger can support different maximum output currents through the settings rotary switch. Setting methods are shown below:

- Before setting the rotary switch, make sure the input power is turned OFF.
- Use a non-conductive object to set the rotary switch.

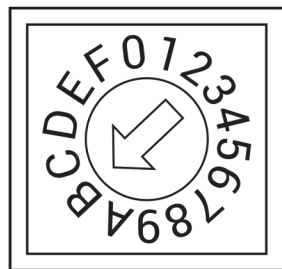

Switch Setting Number	0	1	2	3	4	5	6	7
Maximum Output Current	Test Mode	6 A	8 A	10 A	13 A	16 A	20 A	25 A

Switch Setting Number	8	9	A	B*	C	D	E	F
Maximum Output Current	30 A	32 A	40 A	48 A	Invalid Setting	Invalid Setting	Invalid Setting	Slave Mode

\*The default is 48 A.



## 7.3 Packing List

1

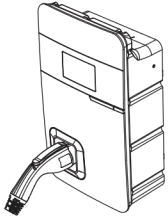

2

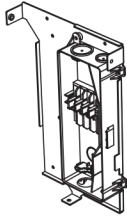

3



4



5



6



7



8



No.	Product Name	Quantity	Note
1	AC Charger (With Charging Cable)	1	
2	Wall-Mount Bracket & Inlet Box	1	
3	User Manual	1	
4	Expansion Screws	4	
5	M5 Self-Tapping Screws	4	
6	Torx/T30 L-Wrench	1	
7	M5 Screws	5	
8	RFID Cards	2	

## 7.4 Tools and Materials Required

Tools required for installing the charger onto the wall-mount bracket are:

- Wire stripper
- Crimpers for ring terminals
- Phillips screwdriver for M4-M6
- 1-3/8 inch or 34 mm drill bit
- Voltmeter or digital multimeter (for measuring AC voltage at the installation site)
- The inserting cable should meet the best waterproof performance. It is recommended to use a 3 core / 6 AWG or 14 mm<sup>2</sup> -10 mm<sup>2</sup> cables (XLPE-90 °C, THHN-90 °C, or equivalent) to pull the cable from the distribution box. The maximum outer diameter of the cable should be 16 mm - 23 mm.
- Level ruler
- Pencil or marker
- Machine drill
- Ring terminal (recommend type 14-5) for 6 AWG wire, and fixed by M5 slotted head screw.
- It is recommended to use 1-inch liquidtight flexible metal conduit compliant with NEMA 4 class
- Slotted head screwdriver for M4.

## 7.5 Wall-Mount Bracket Installation Requirements

Before installing the wall-mount bracket, confirm that the loading capacity of the wall can reach a weight of 40 kg. When installing on a cement wall, use the included expansion screw to install the bracket and use a cement drill to drill holes on the cement wall (Ø8 mm) following the installation steps in next page.

When installing on a wooden wall, use the included M5 self-tapping screws to install the wall-mount bracket to lock and install on the wall directly.

## 7.6 Installation Requirements

- To select the best location and position to install the wall-mount unit, first determine the parking position of the vehicle to ensure the charging connector can be easily inserted into the vehicle charging inlet.

### **The wall-mount unit should be located:**

- In a well-ventilated area; avoid installing in closed environments or near exothermic chargers.
- 1.2 meters or 4 feet above the floor.
- 250 mm (10 inches) from any obstacles to allow cables to loop around the stand and allow to have space for related maintenance.
- On the side of vehicle charging inlet, in an enclosed garage.

## 7.7 Steps for Installation

Warning for Wi-Fi and 4G versions:

Due to potential structural or environmental situations, it is recommended to first conduct Wi-Fi and 4G module network signal tests before finalizing settings. It is recommended that the RSSI (Received Signal Strength Indication) value be higher than -65 dBm. If it is lower than this value, it may result in a weak Wi-Fi or 4G connection or disconnection due to external interference in the area.

## STEP 1

### Installing the wall-mount bracket

Using a pen (or any tool), mark four points on the wall through the installation holes of the bracket, shown in the figure below. Next, install four M5x40 mm plastic expansion screws (in kit package) in the concrete wall. Finally, install the bracket and wire box to the wall.

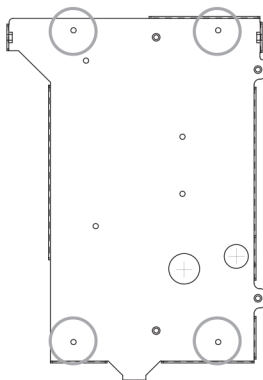

## STEP 2

### Installing the wire box

First, remove the waterproof cover at the inlet end marked as "AC In". Then, install the accessory "1 inch liquid-tight flexible metal conduit" at the inlet of the power cord, and attach the wire box to the wall-mounted sheet metal with screws.

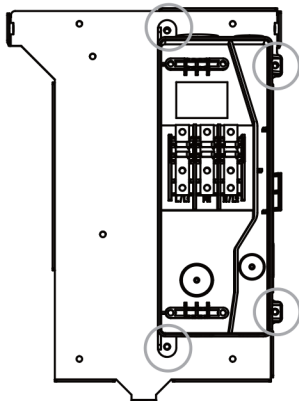

## STEP 3

### Connecting the AC power cord

Three power cords shall be AWG 6 or 14 mm<sup>2</sup>, and shall be fully crimped and connected with O-ring terminals properly. Fasten the cable terminals with the wire box using M5 screws (torque is 40 kg-cm). The corresponding connectors are L1/L, GND/PE, and N/L2, from the left to the right.

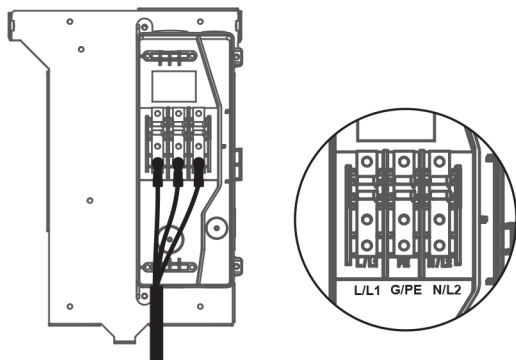

## STEP 4

### Connecting Ethernet cable

Pull the Ethernet cable through the corresponding hole, and insert it into the RJ45 port on the back of the charger (see the next step).

**NOTICE:** Waterproof cable glands are recommended for outdoor usage.

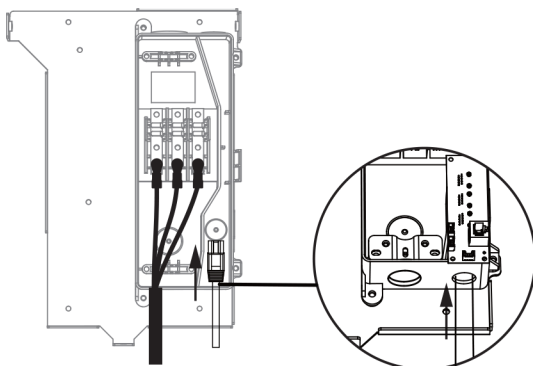

## STEP 5

### Setting the power supply type and grounding type

There are different settings depending on the field and country where the machine is installed. Please refer to Section 7.2 "Power Grid Connection and Grounding Type" for details.

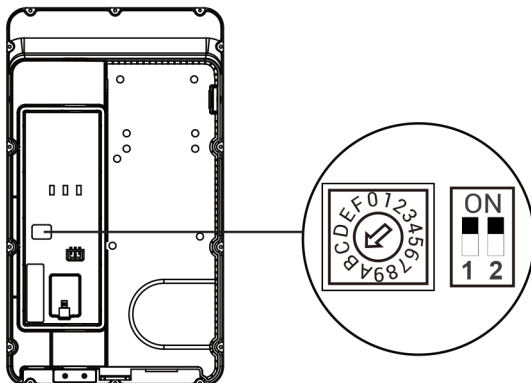

## STEP 6

### Installing the SIM card (only available for 4G models)

**NOTICE:** Please confirm that the SIM card password has been removed before the installation, as the charger post does not support SIM cards with passwords.

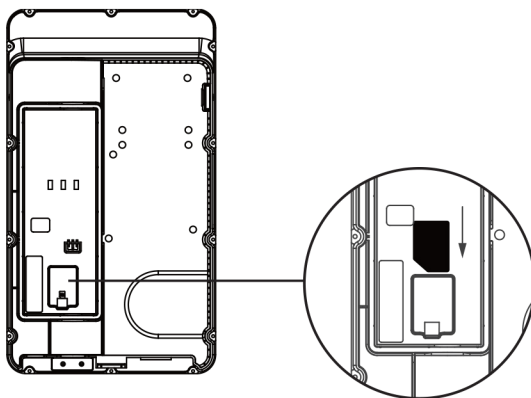

## STEP 7

### Installing the charger

First, connect the network cable to the charger.

**NOTICE:** The network cable needs to be connected to the correct socket.

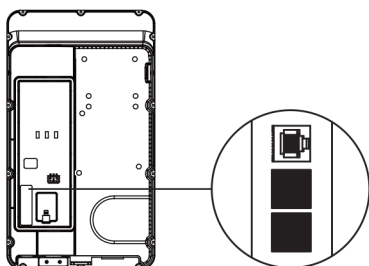

Next, align the charger and the bracket so that the AC blade connectors on the charger can be inserted into the conductive blade connectors of the wire box. Meanwhile, apply pressure to the charger so the 3 screw holes of the charger align with the 3 screw holes on the wall-mount bracket.

Finally, tighten with the M6 Torx screws (Torque 30 kg-cm) in the order of left - right - bottom.

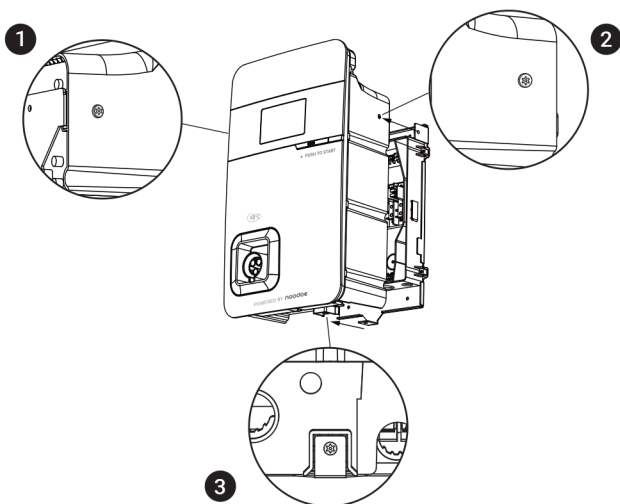

## STEP 8

### Powering on the equipment for setting the charger

For settings instructions, please refer to Chapter 8. "Charger Standard Setting".

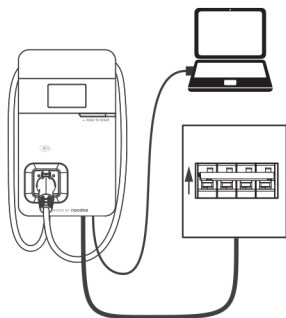

## STEP 9

### Powering off the machine and removing the network cable

Once the setting is completed, power off the equipment and disconnect the network cable. (For wired network connection, proceed to Step 10)

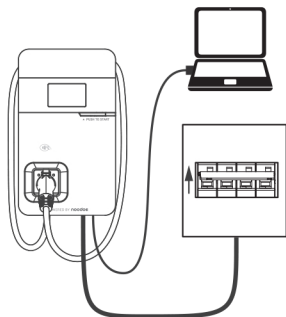



Remove the three screws on the charger in the order of bottom - right - left. Pull the network cable out of the wire box , then remove the network cable. Install the waterproof plug, then re-install the charger and wire box again.

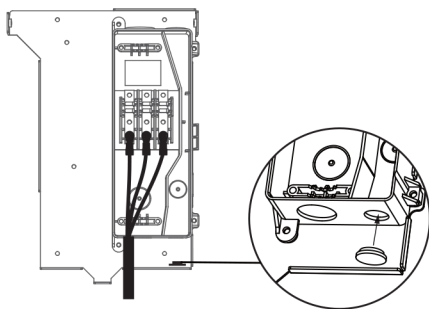
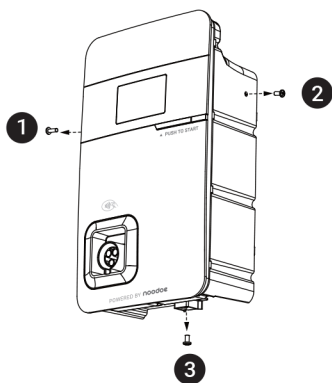

Align the three screw holes of the equipment with the three holes of the wall-mounted sheet metal, then tighten with the M6 plum screws in the order of left - right - bottom using the tightening torque 30 kg-cm.

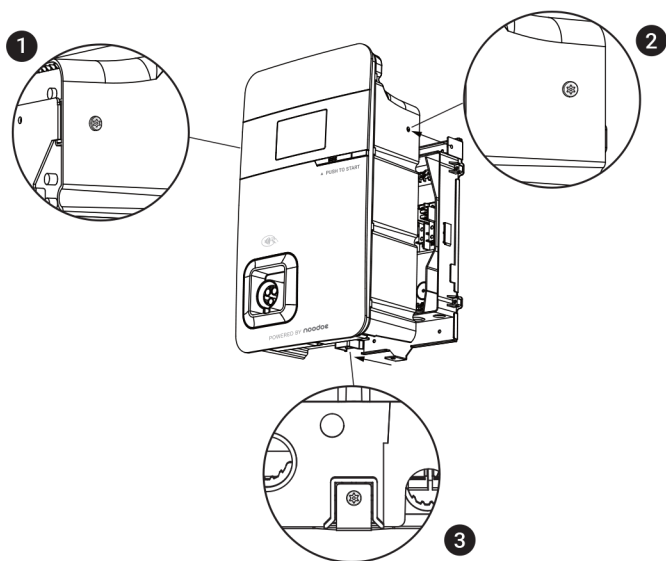

## STEP 10

### Installing the charging gun cable

Wrap the charging gun cable around the equipment so that the charging gun wire will not hang to the ground. Once the cable is wrapped, insert the charging gun head into the hole on the front panel of the machine to complete installation of the equipment.

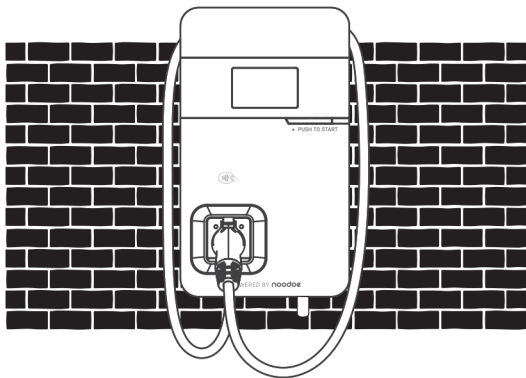

Distributed by [powertechnologysolutions.com](http://powertechnologysolutions.com)

📍 100 Ashley Dr S, Tampa, FL 33402

☎ Phone: (813) 314-7617





✉ E-mail: [sales@powertechnologysolutions.net](mailto:sales@powertechnologysolutions.net)

## 7.8 Gateway Installation

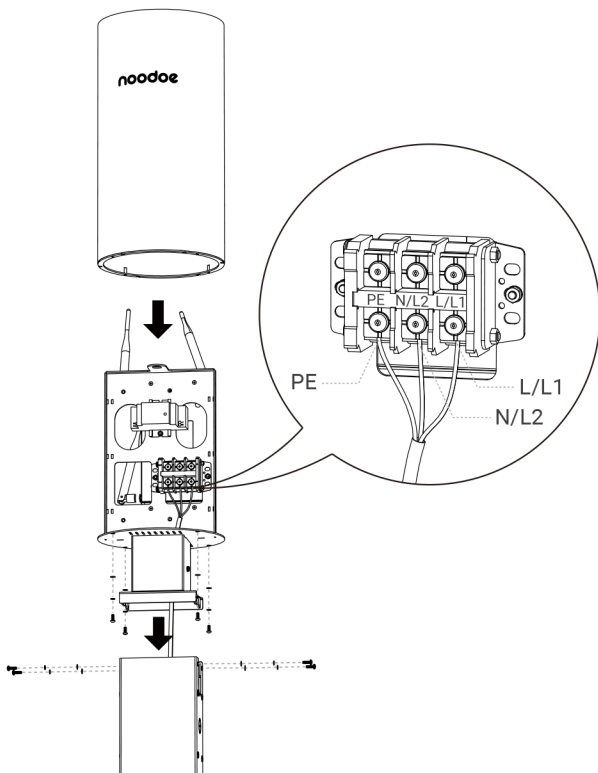
For consistent internet access, we recommended using the Noodoe EV Gateway G120 (please contact Noodoe to purchase).

### 7.8.1 Mounting on the pedestal



No.	Part	Name of Part	Unit
1		M4*12 Phillips Pan Head screws	4
2		M4 Plain washers	8
3		M4 Spring washers	8
4		M4x10 Hex Drive Screws	4

## 7.9 Gateway Installation Scenario

As different installation environments may affect connection quality, we highly recommend thorough consideration of the installation site layout prior to installation. The proper layout will help prevent suboptimal connection quality or disconnection issues.

Best receiving range: radius 18 m (60 feet).

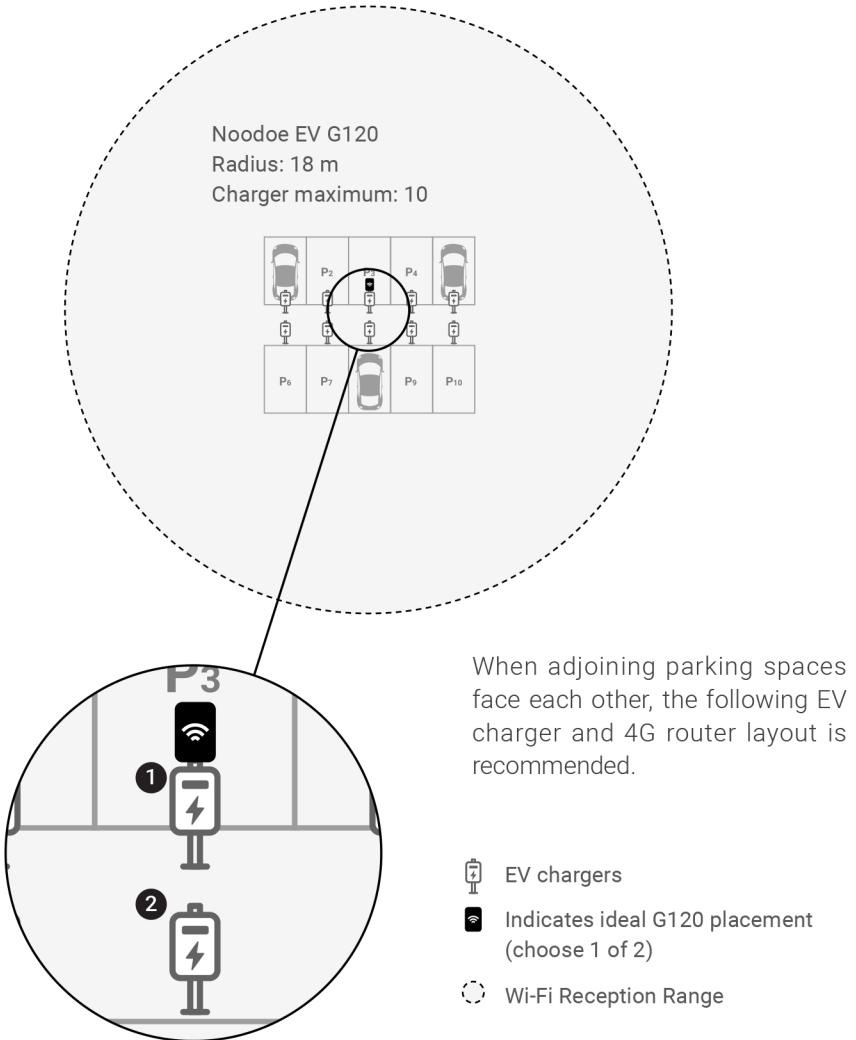

# 8. Charger Standard Setting

## 8.1 Time setting

### Automatic setting :

The time will be adjusted automatically when the charger connects to the internet.

Time server :

- time.windows.com
- cn.ntp.org.cn
- tock.stdtime.gov.tw

Note: Firewall and network environment may influence the time server connection.

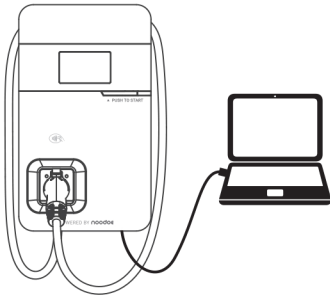

### Step 1

Connect the RJ45 cable to the charger.  
Connect the RJ45 cable to the notebook.

Use the following IP address:

IP address:

Subnet mask:

Default gateway:

### Step 2

Change the IP Address on your laptop computer by accessing the network card settings. Change the TCP / IP automatic IP to fixed IP.

- IP Address: 192.168.1.1
- Subnet Mask: 255.255.255.0

A screenshot of a web browser window. The address bar shows "192.168.1.10". The page content includes the text "login https://192.168.1.10" and two input fields: "Account" with the value "admin" and "Password" with the value "1231231238".

### Step 3

Open a browser and enter IP Address 192.168.1.10 to login into the setup page. Use the following credentials to login.

- Account: admin
- Password: 1231231238

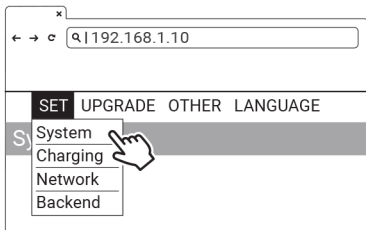

#### Step 4

Select "SET" at the top of the webpage to enter the settings page. Select "System" to enter the time settings page.

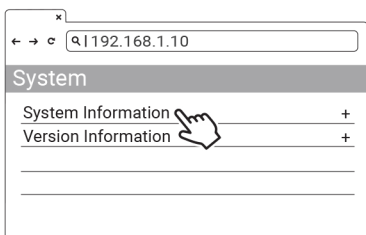

#### Step 5

Click "System information".

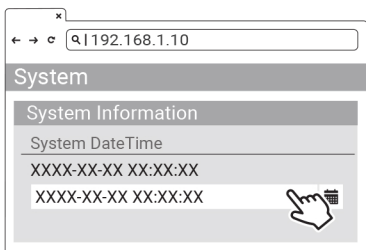

#### Step 6

Click system date time. Click the calendar graphic on the right to set the current time.

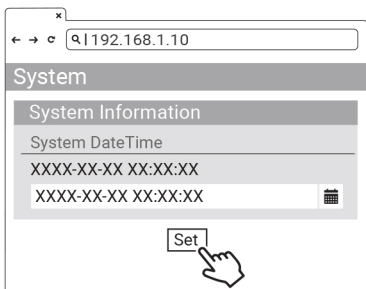

#### Step 7

After the settings are complete, click SET and wait until the setting completion window appears.

For the Networking Edition, restart the charger.

For Wi-Fi and 4G versions, continue to step 8.2 or 8.3 to complete the settings process.

## 8.2 Wi-Fi Setup

Tools required before setting:

- Notebook with RJ45 interface x 1
- One RJ45 cable connector is male to male x1

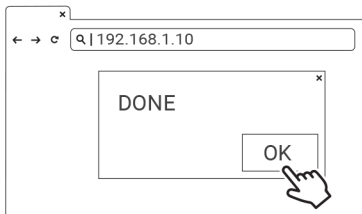
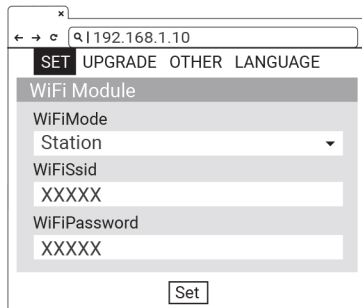
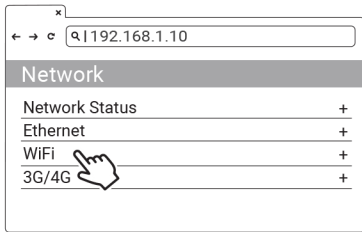
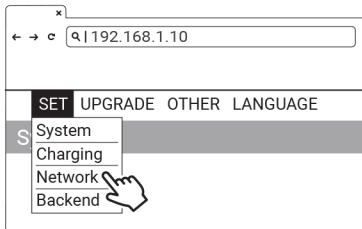

### Step 1

Select "SET" at the top of the webpage to enter the settings page. Select "Network" to enter the network settings page.

### Step 2

Select Wi-Fi to enter the Wi-Fi Module settings page.

### Step 3

Keep the Wi-Fi Mode set to "Station" and enter the Wi-Fi SSID name and the Wi-Fi password. Save settings by selecting "Set".

### Step 4

After completion, click SET and wait until the setting completion window appears. Restart the charger.

\* For other settings (such as OCPP, etc.), please contact our professional staff.



## 8.3 4G Setup (for the Optional 4G Edition)

**NOTICE:** Please confirm that the SIM card password has been removed prior to the installation, as the charger post does not support SIM cards with passwords.

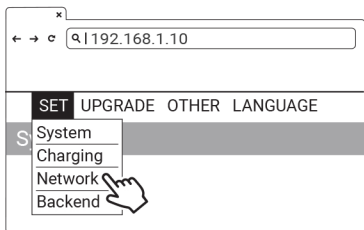

### Step 1

Select "SET" at the top of the webpage to enter the settings page. Select "Network" to enter the network settings page.

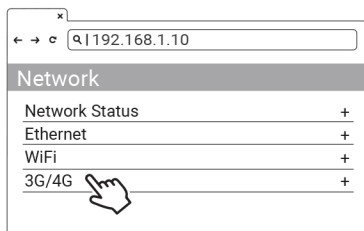

### Step 2

Select 3G/4G module to enter the 4G settings page.

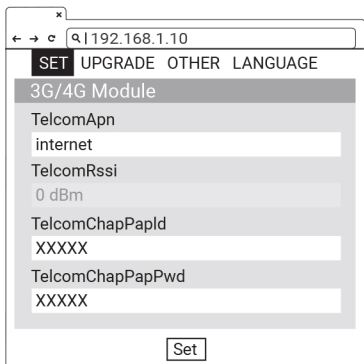

### Step 3

Enter the Carrier APN and then click "OK." Wait for the page to refresh. The page should now show RSSI, and the Network Connection "Status" should show "Connected."

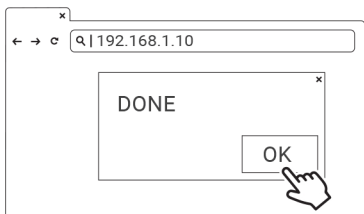

### Step 4

After completion, click SET. Wait for the setting completion window to appear. Click "Confirm" to finish the setting. Restart the charger.

\* For other settings (such as OCPP, etc.), please contact our professional staff.

## 8.4 Re-checking the Wi-Fi and 4G Signal Strength on Power-Up

After restarting the charger, check the connection signal strength. The RSSI (Received Signal Strength Indication) should be higher than -65 dBm. If the value is lower, you may experience a weak Wi-Fi signal connection or even disconnection. The cause could be interference.

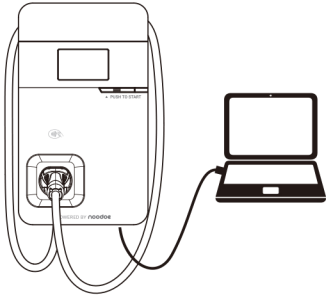

### Step 1

Connect the RJ45 cable to the charger.  
Connect the RJ45 cable to the notebook.

### Step 2

Change the IP Address on your laptop computer by accessing the network card settings. Change the TCP / IP automatic IP to fixed IP.

- IP Address: 192.168.1.1
- Subnet Mask: 255.255.255.0

### Step 3

Open a browser and enter IP Address 192.168.1.10 to login into the setup page. Use the following credentials to login.

- Account: admin
- Password: 1231231238

### Step 4

Select "SET" at the top of the webpage to enter the settings page. Select "Network" to enter the network settings page.

Use the following IP address:

IP address:

Subnet mask:

Default gateway:

← → ↻

login https://192.168.1.10

Account

Password

← → ↻

SET UPGRADE OTHER LANGUAGE

S System

Charging

Network

Backend

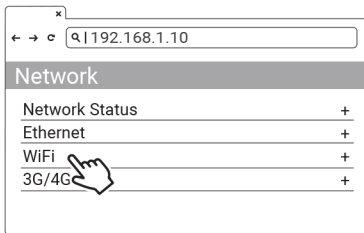

### Step 5

Select the Wi-Fi and 3G/4G module to enter the setting.

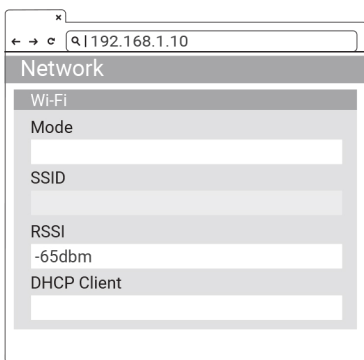

### Step 6

(Wi-Fi Version)

Make sure the Wi-Fi strength is higher than -65 dbm.

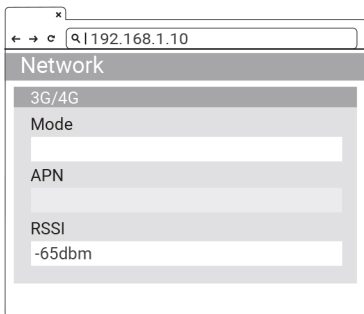

### Step 6

(4G Version)

Check that the strength of 4G must be higher than -65 dbm.

# 9. Operating Instructions

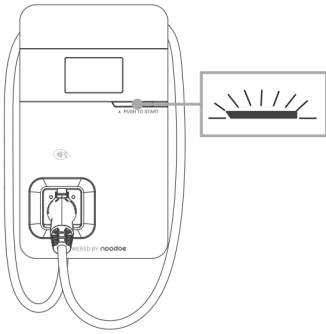

## Standby - Green Light

Wait to see the standby light show STEADY GREEN. When the charger is not operated for 120 seconds, it will enter sleep mode.

When the machine is connected to the backend, the standby light remains GREEN, and it becomes SLEEP GREEN when the machine enters sleep mode.

When the machine is not connected to the backend, the standby light remains YELLOW, and it becomes SLEEP YELLOW when the machine enters sleep mode.



## Press the button to wake up the charger

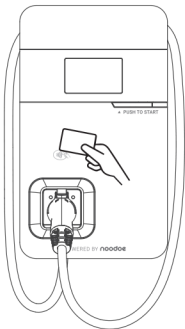

## RFID Authorization (Internet Edition)- Green Light Flashing

The Green light is flashing after the RFID is authorized.

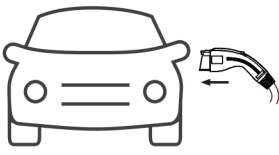

### Waiting for Charging - Blue Light

After the vehicle connector is connected to the vehicle inlet, the CHARGE light is constantly lit.

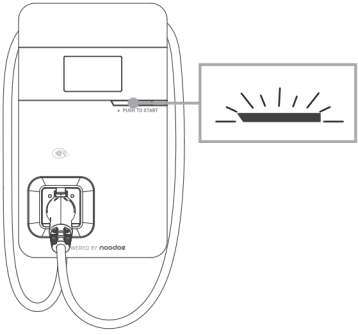

### Charging - Blue Light Flashing

The CHARGE light flashes while charging.

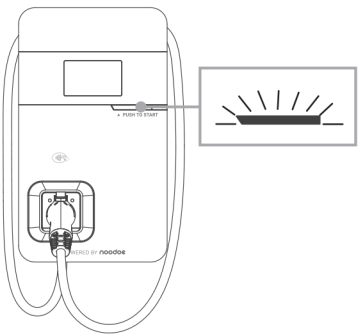

### Fault - Red Light

The red light is lit during fault. Please refer to "9.1 Error and Warning Messages" for detailed information.

## 9.1 Error and Warning Message

Status	Red	Remark
Input OVP	One flash followed by a 3-sec pause	Please measure the input voltage to see if it is higher than 275 V
Input UVP	Two flashes followed by a 3-sec pause	Please measure the input voltage to see if it is lower than 160 V
Output OCP	Three flashes followed by a 3-sec pause	When the charging current on the car shows overloaded, please disconnect the charging gun and then try to initiate charging again. If the situation recurs, please contact the service personnel of the carmaker for identification of problems.
OTP	Four flashes followed by a 3-sec pause	If the temperature of the charger is abnormal, please turn off the power of the charger to cool down the machine before powering it on again. If the situation recurs, please power off and stop using the machine immediately, then contact customer service.
RCD Abnormal	Five flashes followed by a 3-sec pause	Disengage the charging gun and try the operation again. If the situation recurs, please contact customer service.
Ground Fault <sup>*1</sup>	Six flashes followed by a 3-sec pause	Please confirm the grounding status <sup>*1</sup>
Control Pilot Fault	Flicker	When the communication between the vehicle and the charger is abnormal, please disengage the charging gun and re-operate again. If the situation recurs, please contact customer service.
MCU Self-Test Fail	Constantly Bright	Contact Customer Service
RCD Self-Test Fail	Constantly Bright	Contact Customer Service
Relay Self-Test Fail	Constantly Bright	Contact Customer Service

Status	Red	Remark
RCD Abnormal Stop Charging <sup>*2</sup>	Constantly Bright	Contact Customer Service <sup>*3</sup>
Output OCP Stop Charging <sup>*2</sup>	Constantly Bright	Contact Customer Service <sup>*3</sup>
OTP Stop Charging	Constantly Bright	Contact Customer Service

\*1 Verify that the Wall Connector is properly grounded. The Ground connection must be bonded in the upstream power supply for proper operation. Check all physical connections, including the wire box terminals, electrical panel(s), and wire box. In residential power supplies, check the bond between Ground and neutral at the main panel. If connected to a step-down transformer, contact the transformer's manufacturer for direction on how to bond the ground connection.

\*2 Withdraw and re-plug the charging gun can exit this stop charging mode.

\*3 If this stop charging mode is frequently triggered, please contact customer service for technical solutions.

# 10. Activation Instructions

## 10.1 Activation Overview

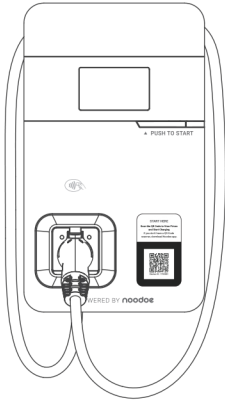

Prior to activation, make sure to collect the necessary information for the site and charging station owner. Each AC11P Exceed has a visible Station ID QR code on them.

- Scan the QR code to begin the activation process through our web portal.
  1. Enter the project code provided by Noodoe EV or your Charge Point Operator. If you do not have one, create a site. (see 10.3)
  2. Confirm or add station ID. (see 10.4)
  3. Upload photos of the charging station. (see 10.5)

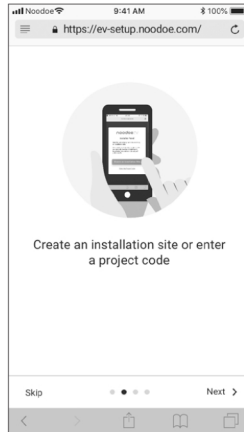
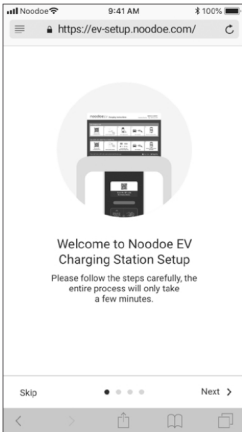



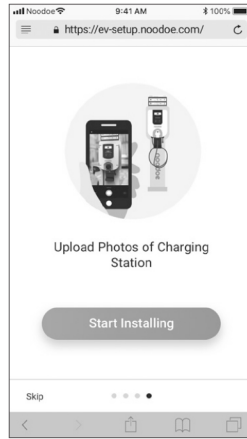
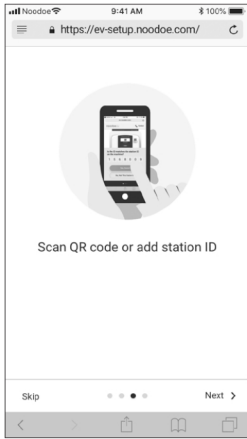

## 10.2 Prior to Activation

Before starting, collect the following information:

- Site Details
  1. Address
  2. Phone number
- Charging Station Owner's Credentials
  1. Full name
  2. Email address
  3. Phone number
- NOTE: The Charging Station Owner is responsible for setting prices, collecting revenue, and ensuring that the subscription service to Noodoe EV OS is paid for.

# 10.3 Creating a Site

If you have a project code provided either by Noodoe EV or your charge point operator, use that to begin the process. If there is no code, choose “Create an Installation Site” to begin activation.

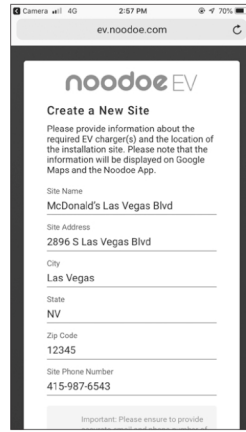
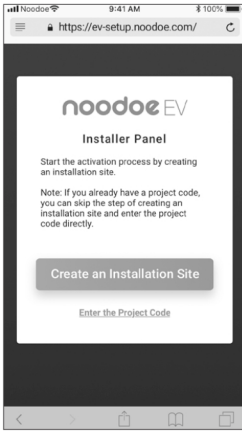

## Site & Owners Information

- To finalize site creation, you will need a few pieces of information. Make sure you have all of this information before moving ahead with the activation procedure.
- Site Information:
  1. Site name
  2. Site address
  3. Site phone number
- Station Owner’s Information
  1. Charging Station Owner’s name
  2. Charging Station Owner’s email address
  3. Charging Station Owner’s phone number
- Installer information
- NOTE: This site information will be used on a charger location map, so it must be accurate. Additionally, the Charging Station Owner of the site will be responsible for managing the chargers, receiving payments made through them, and paying the subscription fees for Noodoe EV OS.

## 10.4 Adding Charging Stations

Make sure the stations are powered up and the site has been created in the setup program.

- Add each station one by one.
  1. Add stations by scanning their QR codes OR
  2. Add stations using their Station IDs

## 10.5 Taking Charging Station Photos

Photos are important for helping EV drivers find your charging stations. Take a photo of each station to be used in Google Maps and in the Noodoe App.

Photo Suggestions:

- Take closeups of each charger (with the QR code visible).
- Include pictures taken from a distance so drivers can see the parking environment.
- State parking instructions where necessary or useful.

# 11. Federal Communication Commission Interference Statement

This device complies with Part 15 of the FCC Rules. Operation is subject to the following two conditions: (1) This device may not cause harmful interference, and (2) this device must accept any interference received, including interference that may cause undesired operation. This equipment has been tested and found to comply with the limits for a Class B digital device, pursuant to Part 15 of the FCC Rules. These limits are designed to provide reasonable protection against harmful interference in a residential installation. This equipment generates, uses and can radiate radio frequency energy and, if not installed and used in accordance with the instructions, may cause harmful interference to radio communications. However, there is no guarantee that interference will not occur in a particular installation. If this equipment does cause harmful interference to radio or television reception, which can be determined by turning the equipment off and on, the user is encouraged to try to correct the interference by one of the following measures:

- Reorient or relocate the receiving antenna.
- Increase the separation between the equipment and receiver.
- Connect the equipment into an outlet on a circuit different from that to which the receiver is connected.
- Consult the dealer or an experienced radio/TV technician for help.

FCC Caution: Any changes or modifications not expressly approved by the party responsible for compliance could void the user's authority to operate this equipment.

This transmitter must not be co-located or operating in conjunction with any other antenna or transmitter.

## **Radiation Exposure Statement:**

This equipment complies with FCC radiation exposure limits set forth for an uncontrolled environment. This equipment should be installed and operated with a minimum distance 20 cm between the radiator and your body.

# 12. Industry Canada Statement

This device complies with ISED's licence-exempt RSSs. Operation is subject to the following two conditions: (1) This device may not cause harmful interference, and (2) this device must accept any interference received, including interference that may cause undesired operation.

Le présent appareil est conforme aux CNR d'ISED applicables aux appareils radio exempts de licence. L'exploitation est autorisée aux deux conditions suivantes : (1) le dispositif ne doit pas produire de brouillage préjudiciable, et (2) ce dispositif doit accepter tout brouillage reçu, y compris un brouillage susceptible de provoquer un fonctionnement indésirable.

## **Radiation Exposure Statement:**

This equipment complies with ISED radiation exposure limits set forth for an uncontrolled environment. This equipment should be installed and operated with a distance greater than 20 cm between the radiator and your body.

## **Déclaration d'exposition aux radiations:**

Cet équipement est conforme aux limites d'exposition aux rayonnements ISED établies pour un environnement non contrôlé. Cet équipement doit être installé et utilisé à plus de 20 cm entre le radiateur et votre corps.

## **This device is intended only for OEM integrators under the following conditions: (For module device use)**

- (1) The antenna must be installed and operated with a distance greater than 20 cm between the antenna and users, and
- (2) The transmitter module may not be co-located with any other transmitter or antenna.

As long as both conditions above are met, further transmitter tests will not be required. However, the OEM integrator is still responsible for testing their end-product for any additional compliance requirements required with this module installed.

## **Cet appareil est conçu uniquement pour les intégrateurs OEM dans les conditions suivantes: (Pour utilisation de dispositif module)**

- (1) L'antenne doit être installé et exploité avec plus de 20 cm entre l'antenne et les utilisateurs, et
- (2) Le module émetteur peut ne pas être coïmplanté avec un autre émetteur ou antenne.

Tant que les 2 conditions ci-dessus sont remplies, des essais supplémentaires sur l'émetteur ne seront pas nécessaires. Toutefois, l'intégrateur OEM est toujours responsable des essais sur son produit final pour toutes exigences de conformité supplémentaires requis pour ce module installé.

**IMPORTANT NOTE:**

In the event that these conditions cannot be met (for example certain laptop configurations or co-location with another transmitter), then the Canada authorization is no longer considered valid and the IC ID cannot be used on the final product. In these circumstances, the OEM integrator will be responsible for re-evaluating the end product (including the transmitter) and obtaining a separate Canada authorization.

**NOTE IMPORTANTE:**

Dans le cas où ces conditions ne peuvent être satisfaites (par exemple pour certaines configurations d'ordinateur portable ou de certaines co-localisation avec un autre émetteur), l'autorisation du Canada n'est plus considéré comme valide et l'ID IC ne peut pas être utilisé sur le produit final. Dans ces circonstances, l'intégrateur OEM sera chargé de réévaluer le produit final (y compris l'émetteur) et l'obtention d'une autorisation distincte au Canada.

# 13. Maintenance

## 13.1 Daily Maintenance

Please keep the charger clean and keep the charger in a clean area with low humidity. Do not install it in an environment near the sea, with high oil, high humidity or high dust.

- Avoid moisture or water in the charger. If water or excess moisture gets into the charger, immediately power off the charger to avoid immediate danger. Proceed to contact the appropriate maintenance personnel before the next use.
- If there is any damage or dirt on the vehicle connector, charging cable, or vehicle connector holder, please contact the maintenance personnel immediately.
- Please use the charger correctly. Do not hit or press hard on the case. If the case is damaged, please contact a professional technician.
- Avoid placing the charger near hot objects and at high-temperature locations and away from dangerous substances such as flammable gases and corrosive materials.
- Do not place external objects or heavy objects on the charger to avoid danger.

## 13.2 Maintenance Spares

This product is equipped with adequate spare maintenance parts for regular maintenance use under and over the warranty period. Warranty services and repairs must be performed by company certified maintenance technicians. For details, please contact the charger distributor or customer service of the company.



Distributed by [powertechnologysolutions.com](http://powertechnologysolutions.com)

 100 Ashley Dr S, Tampa, FL 33402

 Phone: (813) 314-7617

 E-mail: [sales@powertechnologysolutions.net](mailto:sales@powertechnologysolutions.net)